

# Soluciones Visuales

VISUAL SOLUTIONS  
SOLUTIONS VISUELLES





# HOLA

BIENVENIDO AL NUEVO CATÁLOGO

WELCOME TO THE NEW CATALOGUE - BIENVENUE SUR LE NOUVEAU CATALOGUE

**ESP.** Bienvenido a este recorrido por las 6 familias de productos de Planning Sisplamo a través del nuevo catálogo general. Un catálogo reestructurado, ordenado y sobretodo útil. Tu herramienta de trabajo, otro año más a tu disposición.

**ENG.** Welcome to the new Planning Sisplamo general catalogue of products. Restructured, precise and above all useful. Your work tool, another year at your disposal.

**FRA.** Bienvenue sur le parcours de ce nouveau catalogue de produits de Planning Sisplamo Un catalogue restructuré, re-ordonné, et surtout utile. Votre outil de travail une nouvelle fois à votre disposition.

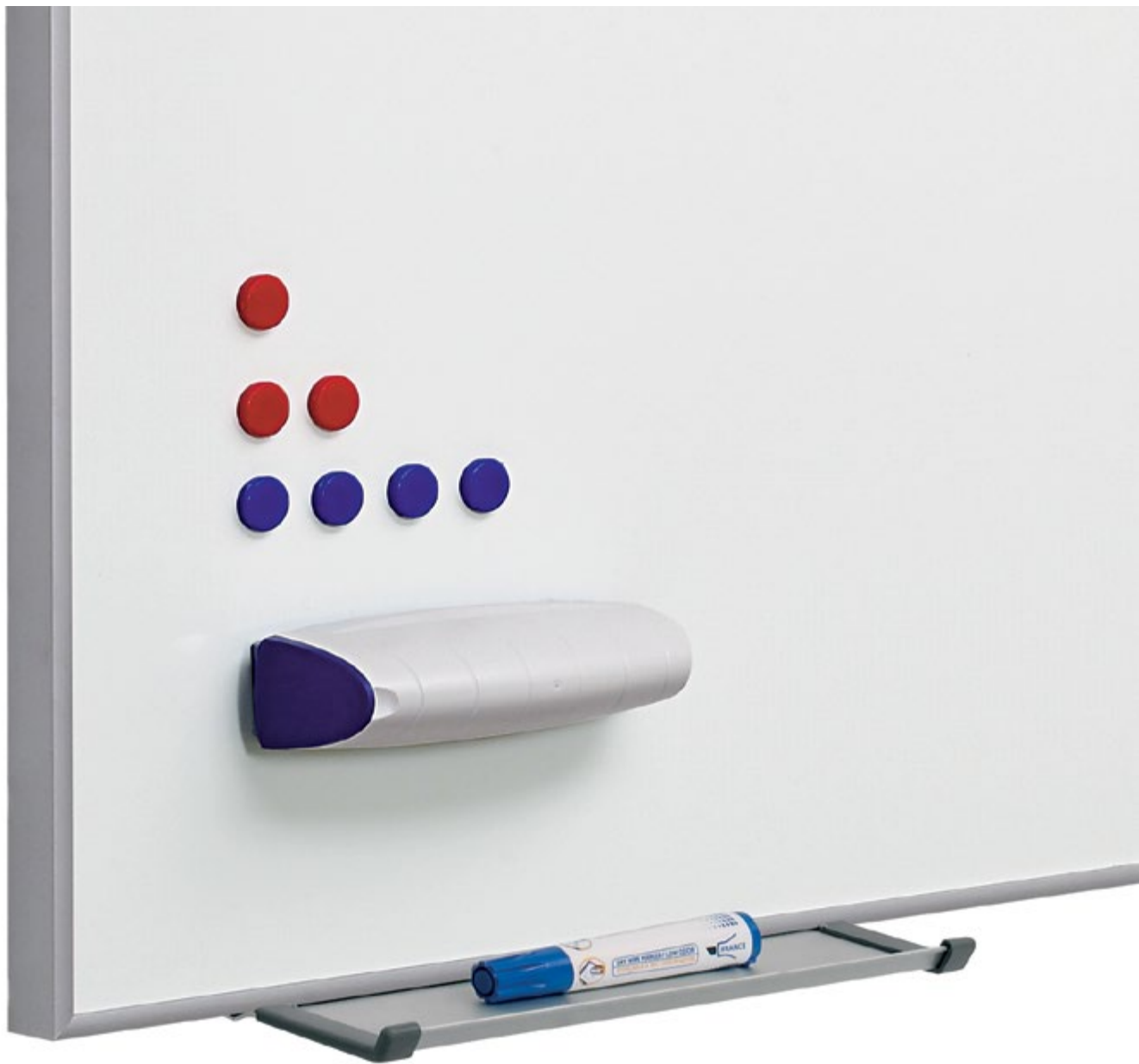



# ÍNDICE

NUESTROS PRODUCTOS  
OUR PRODUCTS - NOS PRODUITS

<b>01.</b>	<b>VISUALPLAN</b>	PAG. 4-59
<b>02.</b>	<b>ESCOLPLAN</b>	PAG. 60-83
<b>03.</b>	<b>INFORMPLAN</b>	PAG. 84-105
<b>04.</b>	<b>EXPOPLAN</b>	PAG. 106-131
<b>05.</b>	<b>MODULPLAN</b>	PAG. 132-167
<b>06.</b>	<b>ROTULPLAN</b>	PAG. 168-189

# **VISUALPLAN**

COMUNICACIÓN VISUAL  
VISUAL COMMUNICATION  
COMMUNICATION VISUELLE





# SUPERFICIES PS

SUPERFICIES DE ESCRITURA  
WRITTING SURFACES - SURFACE D'ÉCRITURE

## SUPERFÍCIE DE CRISTAL

GLASS SURFACE - TABLEAU EN VERRE



**ESP.** Cristal pintado en blanco de 4 mm de grosor, unido con una chapa de 0,8 mm de hierro galvanizado magnética. Fácil mantenimiento y borrado gracias a la baja porosidad del material. Resistente a la abrasión, productos químicos, fuego, bacterias y graffitis.

**ENG.** Glass painted in white 4 mm thick with a 0.8 mm sheet of galvanized iron. Magnetic. Easy maintenance and erasure because of the low porosity of the material. Resistant to graze, chemicals, fire, bacteria and graffiti.

**FRA.** Verre peint en blanc de 4 mm d'épaisseur uni à une tôle en fer galvanisé de 0,8mm. Magnétique, Facile d'entretien grâce à une faible superficie poreuse. Résistante à l'abrasion, produits chimiques, feu, bactéries et graffitis.



728/M - 728/MC - 728 - 728/CO

## SUPERFÍCIE LACADA

LACQUERED SURFACE - SURFACE LAQUÉE



**ESP.** Superficie blanca magnética de chapa metálica lacada cocida a más de 100°C. Incluye chapa de aluminio para mayor resistencia. Fácil mantenimiento.

**ENG.** Magnetic white surface of lacquered metal sheet heated to more than 100°C. Includes aluminum foil for added strength. Easy maintenance.

**FRA.** Superficie blanche magnétique grâce à une tôle métallique laquée cuite à plus de 100°C. Inclus renfort en aluminium pour une plus grande résistance. Facile d'entretien.

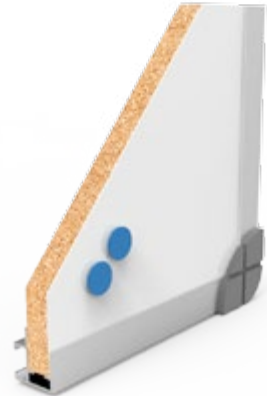

BL/VI - 722 - 724/LC - FLIPCHARTS - 1000

## SUPERFÍCIE LAMINADA

LAMINATED SURFACE - SURFACE STRATIFIÉE



**ESP.** Superficie de escritura blanca en plancha laminada de alta presión (HPL). Extremadamente resistente a los impactos y desgaste. Fácil mantenimiento. No magnética.

**ENG.** White writing surface in high pressure laminated board (HPL). Extremely resistant to impacts and usage. Easy maintenance. Not magnetic.

**FRA.** Superficie d'écriture blanche en planche laminée à haute pression (HPL). Extrêmement résistante aux impactes et usure. Facile d'entretien. Non magnétique.



725 - 725/X





## SUPERFÍCIE DE **ACERO VITRIFICADO** ENAMELLED SURFACE - SURFACE ÉMAILLÉE



**ESP.** Superficie blanca en acero vitrificado formada por una lámina central de acero de 0,7 mm cubierta con un revestimiento delgado de esmalte, que se funde con el acero a 800°C. Fabricado con un 30% de acero reciclado. Reciclable al 99,9%. Garantía de por vida. Resistente a rayaduras, abrasión, productos químicos, fuego, bacterias y graffitis. Fácil mantenimiento. Mayor contraste de color. Visibilidad mejorada y óptima comodidad visual. Magnética.

**ENG.** White surface in vitrified steel formed by a 0.7 mm steel core sheet covered with a thin coating of enamel, which melts with the steel at 800 ° C. Made with 30% recycled steel. Recyclable at 99.9%. Lifetime warranty. Resistant to scratches, abrasion, chemicals, fire, bacteria and graffiti. Easy maintenance. Higher color contrast. Improved visibility and optimum visual comfort. Magnetic.

**FRA.** Superficie blanc en acier vitrifié formé par une tôle d'acier de 0,7mm recouverte d'un revêtement émaillé fondu à 800°C. Fabriqué avec 30% d'acier recyclé. Recyclable à 99,9%. Garantie à vie. Résistant aux rayures, abrasion, produits chimiques, feu, bactéries et graffitis. Facile d'entretien. Grand contraste de couleur. Visibilité améliorée et qualité visuel optimum. Magnétique.

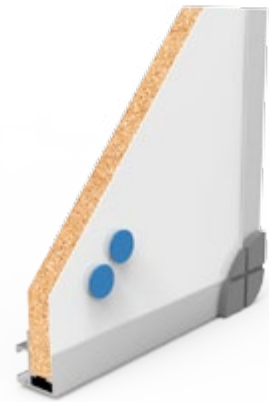

720 - 720/C - 720/P - 724 - ZENIT - 720/D  
720/T - 720/X - 720/2/MV - 720/2/G - LEAN  
CHAMELEON



La superficie e3 CeramicSteel es la única del sector a nivel mundial con la certificación:

**Cradle to Cradle Certified TM Bronze**

Norma ISO 9001

## PERFIL DE LA SUPERFÍCIE SURFACES PROFILE - PROFIL DE SURFACE

**ESP.** Los perfiles que enmarcan las pizarras de Planning Sisplamo son de aluminio anodizado. Las cantoneras, que ocultan el tornillo, son piezas fabricadas por inyección de ABS.

**ENG.** The profiles framing Planning Sisplamo white boards are anodized aluminum. The corners, which conceal the screw, are manufactured by injection ABS.

**FRA.** Les profils qui encadrent les tableaux Planning Sisplamo sont en aluminium anodisé. Les coins, qui cachent la fixation, sont des pièces fabriquée par injection d'ABS.

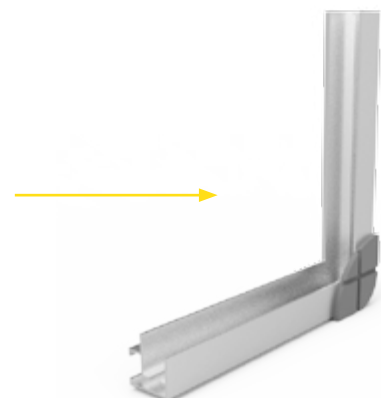

# GUÍA PS

ESCOGE TU PIZARRA  
CHOOSE YOUR WHITEBOARD - CHOISIR VOTRE TABLEAU



## **PERSONAL** PERSONAL - PERSONALE

**ESP.** Pizarras de uso personal para el uso en el hogar o en salas de pequeñas dimensiones. Disponibles en versión mural, con soportes, en diferentes materiales y colores.

**ENG.** Whiteboards for use in the home or in small rooms. Available in mural version, with supports, in varied materials and many colors.

**FRA.** Tableau à usage personnel pour la maison ou de petites pièces/bureaux.. Disponible en version murale, avec support et en différents matériaux et couleurs.

- **BASIC**
- **722**
- ZENIT
- 728
- **728/CO**
- CHAMELEON
- FLIPCHARTS

## **BUSINESS** BUSINESS - NEGOTIATIONS

**ESP.** Pizarras para uso en salas de reuniones o aulas de estudiantes reducidas. Disponibles en versión mural, con soporte y en diferentes materiales.

**ENG.** Whiteboards for use in meeting rooms or small classrooms. Available wall version, with supports, and in different materials.

**FRA.** Tableaux pour usage en salles de réunions et petites salles de classe. Disponibles en version murale, avec supports et en différents matériaux.

- 720
- 725
- **724**
- **ZENIT**
- 728/M
- 728/MC
- 728
- 728/CO
- 720/X
- 725/X
- **CHAMELEON**
- LEAN
- 1000

## **ESCUELA** SCHOOL - ÉCOLE

**ESP.** Pizarras para el uso en aulas de mayor dimensión para más estudiantes. Disponibles en versión mural y en diferentes materiales.

**ENG.** Whiteboards for use in larger classrooms for more students. Available mural version and different materials.

**FRA.** Tableaux pour usage en salle de grande dimension pour plus d'étudiants. Disponible en version murale et en différents matériaux.

- **720**
- **720/C**
- **720/P**
- ZENIT
- RAIL
- 720/D
- 720/T
- **CHAMELEON**
- FLIPCHARTS
- **720/VV**
- **720/G**





1.

ESP Selecciona el perfil en el cual clasificarás tu captura.

ENG Select the profile in which you will classify your.

FRA Sélectionnez le profil dans lequel vous organiserez vos captures.



2.

ESP Encaja el contenido de la pizarra a la pantalla de tu smartphone. Espera a que dispare o dispara tú mismo.

ENG Embed the content of the whiteboard to the screen of your smartphone. Wait for automatic image or take picture yourself.

FRA Réajustez le contenu du tableau à l'écran de votre smartphone. Attendez la capture automatique ou faites-le manuellement.



3.

ESP Clasifica la imagen por etiquetas según asignaturas o temas.

ENG Sort the image using tags according to subjects.

FRA Ordonnez vos images par étiquettes suivant la matière ou le thème.



4.

ESP Comparte tus notas, apuntes o fotos con quien quieras a través mail, whatsapp u otras aplicaciones.

ENG Share your notes or photos with whoever you want via mail, whatsapp or other applications.

FRA Partagez vos notes, vos croquis ou photos avec qui vous le souhaitez par email, sms ou autres app.



# PS Capture

by Planning Sisplamo

Capta, clasifica y comparte el contenido de tu pizarra.  
Capture, classify and share the content of your board.  
Capturez, ordenez et partagez le contenu de votre tableau.



[planningsisplamo.com/pscapture](http://planningsisplamo.com/pscapture)

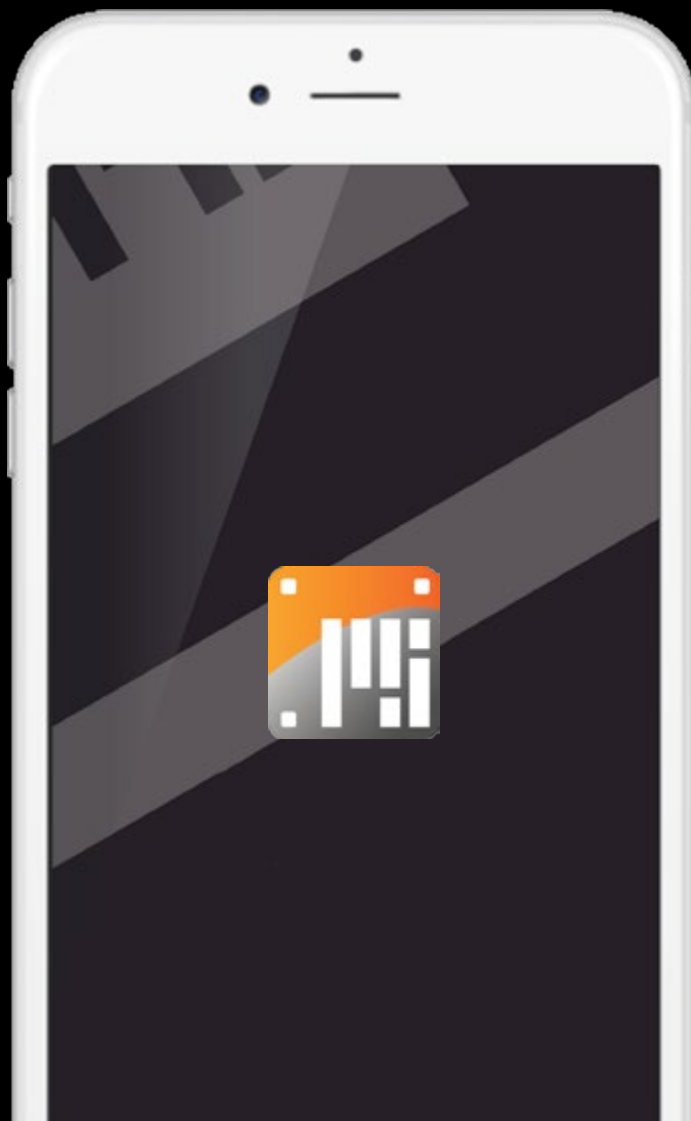

# BASIC

PIZARRA LACADA  
LACQUERED WHITEBOARD - TABLEAU LAQUÉ



REF	L	H	□
BL/VI/0010	45 x 60	1	30
BL/VI/0011	60 x 90	1	30
BL/VI/0012	90 x 120	1	30
BL/VI/0013	100 x 150	1	30

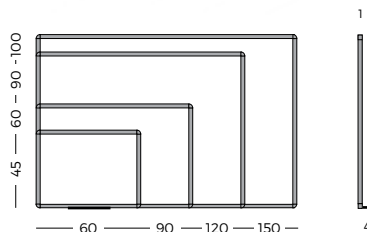

## PIZARRA BASIC

**ESP.** Pizarra Basic lacada blanca. Enmarcada con perfil de aluminio anodizado en color plata mate y cantoneras redondeadas de plástico gris. Rotulable en seco. Magnética. Incluye cajetín reposarrotuladores de 30 cm.

## BASIC WHITEBOARD

**ENG.** Basic lacquered whiteboard. Equipped with silver anodized aluminium frame and grey plastic rounded corners. Suitable for writing with dry wipe board markers. Magnetic. A 30 cm. pen tray included.

## TABLEAU BASIC

**FRA.** Tableau Basic laqué blanc. Encadrement en aluminium anodisé couleur argent aux coins arrondis en plastique gris. Effaçable à sec. Magnétique. Livré avec un auget porte marqueurs de 30 cm.



# 722

PIZARRA LACADA  
LACQUERED WHITEBOARD - TABLEAU LAQUÉ

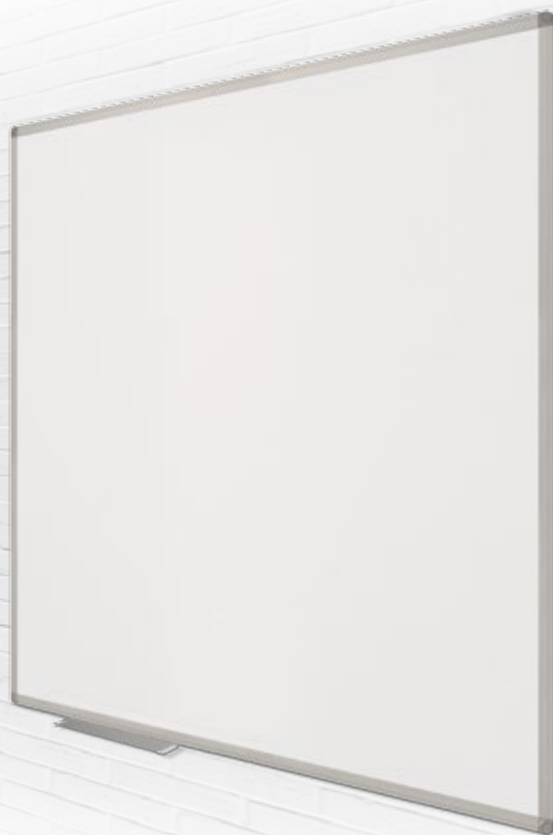

REF	L	H	RAIL	RAIL
<b>722/1</b>	45 x 60	2,2	30	-
<b>722/2</b>	60 x 90	2,2	30	✓
<b>722/3</b>	90 x 120	2,2	30	✓
<b>722/5</b>	100 x 150	2,2	30	✓
<b>722/6</b>	100 x 200	2,2	30	-
<b>722/7</b>	100 x 250	2,2	30	-

Disponibles + soporte T

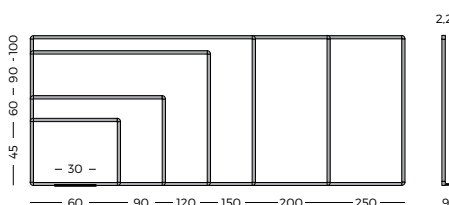

## PIZARRA LACADA

**ESP.** Pizarra mural lacada blanca. Enmarcada con perfil de aluminio anodizado en color plata mate y cantoneras redondeadas de plástico gris. Rotulable en seco. Magnética. Incluye cajetín reposarrotuladores de 30 cm.

## LACQUERED WHITEBOARD

**ENG.** Lacquered whiteboard. Equipped with silver anodized aluminium frame and grey plastic rounded corners. Suitable for writing with dry wipe board markers. Magnetic. 30 cm. pen tray included.

## TABLEAU LAQUÉ

**FRA.** Tableau laqué blanc. Encadrement en aluminium anodisé couleur argent aux coins arrondis en plastique gris. Effaçable à sec. Magnétique. Livré avec auget porte marqueurs 30 cm.

# 725

PIZARRA LAMINADA  
LAMINATED WHITEBOARD - TABLEAU STRATIFIÉ



REF	L	H	RAIL
725/1	40 x 60	2.2	30 -
725/2	60 x 80	2.2	30 -
725/3	80 x 120	2.2	30 ✓
725/4	100 x 120	2.2	30 ✓
725/5	120 x 150	2.2	30 ✓
725/6	120 x 175	2.2	30 ✓
725/7	120 x 200	2.2	30 -
725/8	120 x 250	2.2	30 -
725/9	120 x 300	2.2	30 -

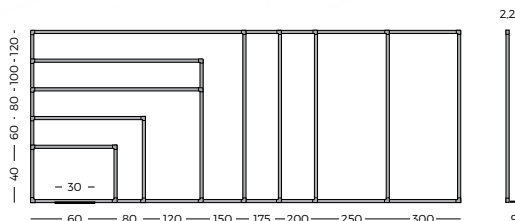

REF	L	H	RAIL
725/5/M	120 x 150	2.2	30 ✓
725/7/M	120 x 200	2.2	30 -
725/8/M	120 x 250	2.2	30 -

Solo para proyección - No rotulable  
Only for projection - Not for writing  
Uniquement par projection - Pas pour écrire



## PIZARRA LAMINADA

**ESP.** Pizarra laminada blanca. Superficie laminada en alta presión. Enmarcada con perfil de aluminio anodizado en color plata mate y cantoneras redondeadas de plástico gris. Rotulable en seco. Incluye cajetín reposarrotuladores de 30 cm.

## LAMINATED WHITEBOARD

**ENG.** High-pressure laminated whiteboard. Equipped with silver anodized aluminium frame and grey plastic rounded corners. Suitable for writing with dry wipe board markers. A 30 cm. pen tray included.

## TABLEAU STRATIFIÉ

**FRA.** Tableau stratifié blanc. Encadrement en aluminium anodisé couleur argent aux coins arrondis en plastique gris. Surface effaçable à sec. Livré avec un auget porte marqueurs de 30 cm.





### SORTE T

REF	↑	L	⊥	□
<b>705/L</b>	190	100 x 80	53	30
<b>706/L</b>	190	100 x 120	53	30
<b>713/L</b>	190	120 x 150	53	30
<b>714/L</b>	190	120 x 200	53	30



### SORTE DELTA

REF	↑	L	⊥	□
<b>707/L</b>	190	100 x 80	53	30
<b>708/L</b>	190	100 x 120	53	30
<b>715/L</b>	190	120 x 150	53	30
<b>716/L</b>	190	120 x 200	53	30



### SORTE Y2

REF	↑	L	⊥	□
<b>+ Y2/80</b>	190	80 x 100	53	30
<b>+ Y2/120</b>	190	100 x 120	53	30
<b>+ Y2/150</b>	190	120 x 150	53	30
<b>+ Y2/175</b>	190	120 x 175	53	30
<b>+ Y2/200</b>	190	120 x 200	53	30

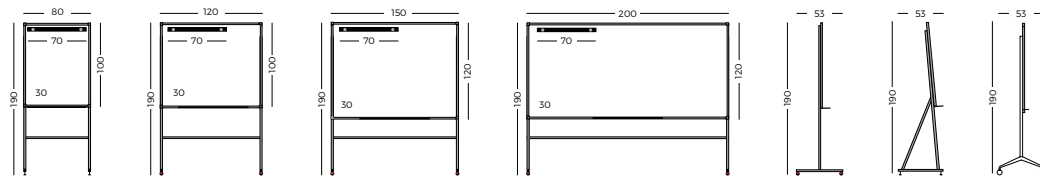

**PS Capture**  
 App by Planning Sislamo  
[www.planningsislamo.com/pscapture](http://www.planningsislamo.com/pscapture)



### ACCESORIOS

7012



7014



7008



# 720

PIZARRA DE ACERO VITRIFICADO  
ENAMELLED WHITEBOARD - TABLEAU ÉMAILLÉ



REF	L	H	RAIL
<b>720/10</b>	40 x 60	2.2	30 -
<b>720/1</b>	60 x 80	2.2	30 -
<b>720/2</b>	80 x 100	2.2	30 ✓
<b>720/3</b>	100 x 120	2.2	30 ✓
<b>720/4</b>	100 x 150	2.2	30 ✓
<b>720/5</b>	100 x 175	2.2	30 ✓
<b>720/6</b>	120 x 200	2.2	30 -
<b>720/7</b>	120 x 250	2.2	30 -
<b>720/8</b>	120 x 300	2.2	30 -
<b>720/9</b>	120 x 400	2.2	30 -
<b>720/15</b>	150 x 300	2.2	30 -

REF	L	H	RAIL
<b>720/4/M</b>	120 x 150	2.2	30 ✓
<b>720/6/M</b>	120 x 200	2.2	30 -
<b>720/7/M</b>	120 x 250	2.2	30 -
<b>720/8/M</b>	120 x 300	2.2	30 -
<b>720/9/M</b>	120 x 400	2.2	30 -
<b>720/15/M</b>	150 x 300	2.2	30 -

Para proyección  
For projection  
Par projection

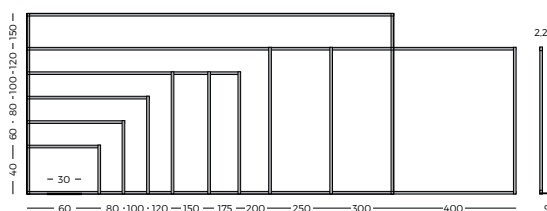

## PIZARRA DE ACERO VITRIFICADO

**ESP.** Pizarra mural de acero vitrificado blanco. Enmarcada con perfil de aluminio anodizado en color plata mate. Superficie de acero vitrificado a 800°C con garantía de por vida. Rotulable en seco. Magnética. Incluye cajetín de 30 cm.

## ENAMELLED WHITEBOARD

**ENG.** Enamelled whiteboard. Equipped with silver anodized aluminium frame and plastic rounded corners. Surface enamelled at 800°C. Suitable for writing with dry wipe board markers. Magnetic. 30 cm tray included. Lifetime warranty.

## TABLEAU ÉMAILLÉ

**FRA.** Tableau émaillé blanc. Encadrement en aluminium anodisé couleur argent aux coins arrondis en plastique. Surface émaillée vitrifiée à 800°C. Livré avec auget porte marqueurs de 30 cm. Magnétique. Garantie à vie.



### SOPORTE T

REF	↑	L	⊥	□
<b>705/A</b>	190	100 x 80	53	30
<b>706/A</b>	190	100 x 120	53	30
<b>713/A</b>	190	100 x 150	53	30
<b>714/A</b>	190	120 x 200	53	30



### SOPORTE DELTA

REF	↑	L	⊥	□
<b>707/A</b>	190	100 x 80	53	30
<b>708/A</b>	190	100 x 120	53	30
<b>715/A</b>	190	100 x 150	53	30
<b>716/A</b>	190	120 x 200	53	30



### SOPORTE Y2

REF	↑	L	⊥	□
<b>+ Y2/80</b>	190	80 x 100	53	30
<b>+ Y2/120</b>	190	100 x 120	53	30
<b>+ Y2/150</b>	190	100 x 150	53	30
<b>+ Y2/200</b>	190	120 x 200	53	30

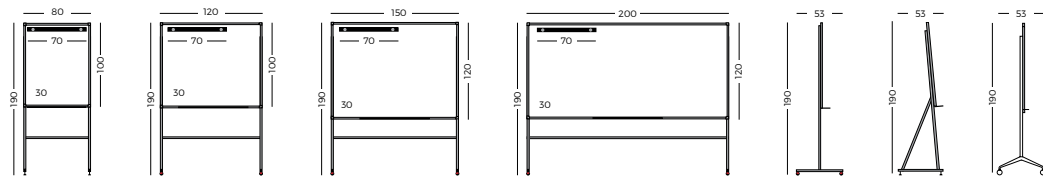

**PS Capture**  
 App by Planning Sislamo  
[www.planningsislamo.com/pscapture](http://www.planningsislamo.com/pscapture)



### ACCESORIOS

7006



7019



9002



# 720/C-720/P

PIZARRA DE ACERO VITRIFICADO CON CUADRICULA/PENTAGRAMA  
 GRID/PENTAGRAM - QUADRILLÉ/PENTAGRAMME

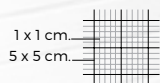
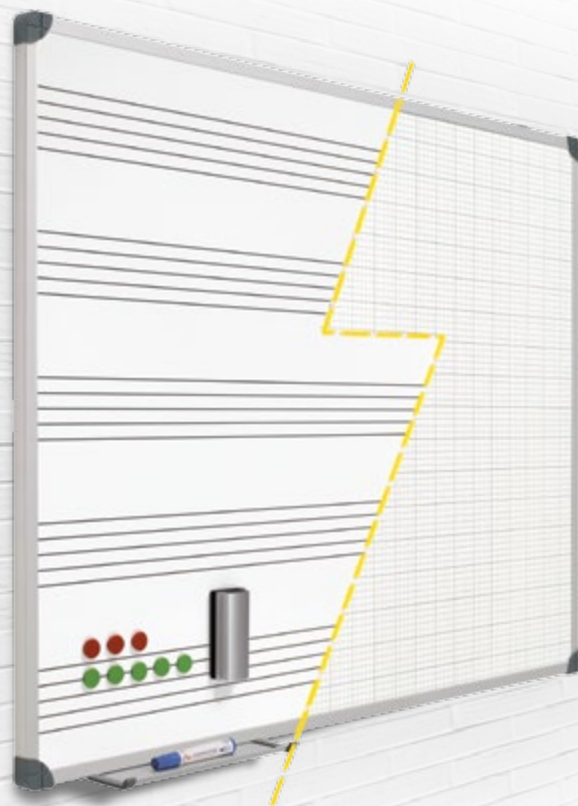
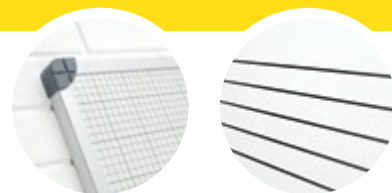

REF	L	H	RAIL
<b>720/C1</b>	45 x 60	2.2	30 -
<b>720/C2</b>	60 x 90	2.2	30 -
<b>720/C3</b>	90 x 120	2.2	30 ✓
<b>720/C4</b>	120 x 180	2.2	30 ✓

REF	L	H	RAIL
<b>720/P1</b>	120 x 150	2.2	30 ✓
<b>720/P2</b>	120 x 200	2.2	30 -
<b>720/P3</b>	120 x 300	2.2	30 -

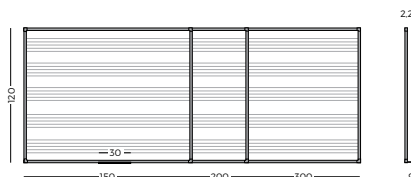

## PIZARRA CUADRICULADA/PENTAGRAMA

**ESP.** Pizarra mural de acero vitrificado blanco con cuadrícula o pentagrama. Enmarcada con perfil de aluminio anodizado en color plata mate. Superficie de acero vitrificado a 800°C con garantía de por vida. Rotulable en seco. Magnética. Incluye cajetín de 30 cm.

## GRIDED/PENTAGRAM WHITEBOARD

**ENG.** Enamelled grided or pentagram whiteboard. Equipped with silver anodized aluminium frame and plastic rounded corners. Surface enamelled at 800°C. Suitable for writing with dry wipe board markers. Magnetic. 30 cm tray included. Lifetime warranty.

## TABLEAU QUADRILLÉ/PENTAGRAMME

**FRA.** Tableau émaillé blanc quadrillé ou pentagramme. Encadrement en aluminium anodisé couleur argent aux coins arrondis en plastique. Surface émaillée vitrifiée à 800°C. Livré avec auget porte marqueurs de 30 cm. Magnétique. Garantie à vie.



### SOPORTE T

REF	↑	L	⊥	□
<b>720/C3/T</b>	190	90 x 120	53	30
<b>720/C4/T</b>	190	120 x 180	53	30
<b>720/P1/T</b>	190	120 x 150	53	30
<b>720/P2/T</b>	190	120 x 200	53	30



### SOPORTE DELTA

REF	↑	L	⊥	□
<b>720/C3/D</b>	190	90 x 120	53	30
<b>720/C4/D</b>	190	120 x 180	53	30
<b>720/P1/D</b>	190	120 x 150	53	30
<b>720/P2/D</b>	190	120 x 200	53	30



### SOPORTE Y2

REF	↑	L	⊥	□
<b>+ Y2/120</b>	181	100 x 120	53	30
<b>+ Y2/150</b>	181	100 x 150	53	30
<b>+ Y2/200</b>	181	120 x 200	53	30

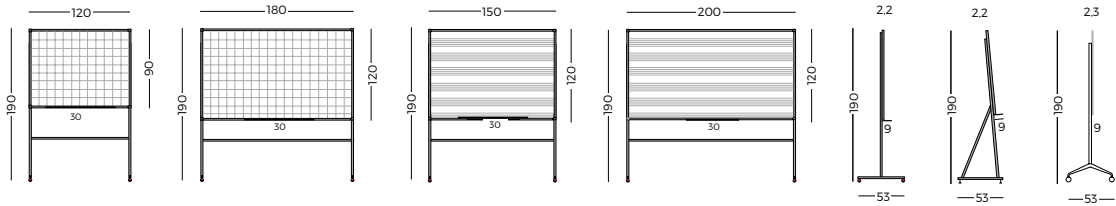

**PS Capture**  
 App by Planning Sisplamo  
[www.planningsisplamo.com/pscapture](http://www.planningsisplamo.com/pscapture)



### ACCESORIOS

7006



7019



9002



# 724

PIZARRA DE ACERO VITRIFICADO CON MARCO 'MINI'  
WHITEBOARD 'MINI' - TABLEAU 'MINI'



REF	L	H	RAIL
724/10	40 x 60	2.3	30 -
724/1	60 x 80	2.3	30 -
724/2	80 x 100	2.3	30 ✓
724/3	100 x 120	2.3	30 ✓
724/4	100 x 150	2.3	30 ✓
724/5	100 x 175	2.3	30 ✓
724/6	120 x 200	2.3	30 -

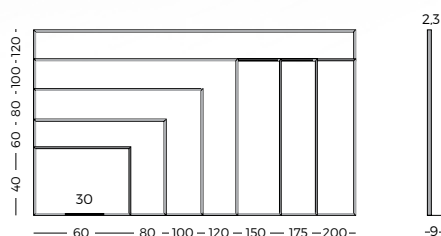

REF	L	H	RAIL
724/10/LC	45 x 60	2.3	30 -
724/1/LC	60 x 90	2.3	30 -
724/2/LC	80 x 100	2.3	30 ✓
724/3/LC	90 x 120	2.3	30 ✓
724/4/LC	100 x 150	2.3	30 ✓
724/5/LC	100 x 175	2.3	30 ✓
724/6/LC	100 x 200	2.3	30 -



## PIZARRA DE ACERO VITRIFICADO 'MINI'

**ESP.** Pizarra mural de acero vitrificado blanco. Enmarcada con perfil de aluminio anodizado Mini en color plata mate. Superficie de acero vitrificado a 800°C con garantía de por vida. Rotulable en seco. Magnética. Incluye cajetín de 30 cm.

## ENAMELLED WHITEBOARD 'MINI'

**ENG.** Enamelled whiteboard. Equipped with Mini silver anodized aluminium frame and mitred corners. Surface enamelled at 800°C. Suitable for writing with dry wipe board markers. Magnetic. 30 cm tray included. Lifetime warranty.

## TABLEAU ÉMAILLÉ 'MINI'

**FRA.** Tableau émaillé blanc. Encadrement Mini en aluminium anodisé couleur argent. Surface émaillée vitrifiée à 800°C. Livré avec auget porte marqueurs de 30 cm. Magnétique. Garantie à vie.



**SORTE T**

REF	↑	L	⊥	□
<b>724/T2</b>	190	100 x 80	53	30
<b>724/T3</b>	190	100 x 120	53	30
<b>724/T4</b>	190	100 x 150	53	30
<b>724/T6</b>	190	120 x 200	53	30



**SORTE DELTA**

REF	↑	L	⊥	□
<b>724/D2</b>	190	100 x 80	53	30
<b>724/D3</b>	190	100 x 120	53	30
<b>724/D4</b>	190	100 x 150	53	30
<b>724/D6</b>	190	120 x 200	53	30



**SORTE Y2**

REF	↑	L	⊥	□
<b>724/Y2</b>	181	100 x 80	53	30
<b>724/Y3</b>	181	100 x 120	53	30
<b>724/Y4</b>	181	100 x 150	53	30
<b>724/Y6</b>	181	120 x 200	53	30

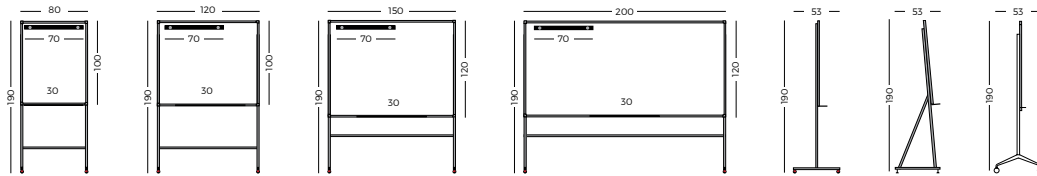

**PS Capture**  
 App by Planning Sisplamo  
[www.planningsisplamo.com/pscapture](http://www.planningsisplamo.com/pscapture)



**ACCESORIOS**

**7006**



**7019**



**9002**



# 728/M

PIZARRA DE CRISTAL  
GLASSBOARD - TABLEAU EN VERRE



REF	L	H	⊠
728/M1	60 x 80	2.3	30
728/M2	80 x 100	2.3	30
728/M3	100 x 120	2.3	30
728/M4	100 x 150	2.3	30
728/M5	100 x 175	2.3	30

+ T	+ DELTA	+ Y2				
REF	REF	REF	⊠	L	H	⊠
728/M2/T	728/M2/D	728/M2/Y	190	80 x 100	53	30
728/M3/T	728/M3/D	728/M3/Y	190	100 x 120	53	30
728/M4/T	728/M4/D	728/M4/Y	190	100 x 150	53	30
728/M5/T	728/M5/D	728/M5/Y	190	100 x 175	53	30

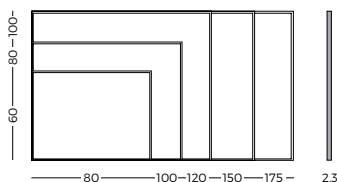

## PIZARRA DE CRISTAL

**ESP.** Pizarra de cristal laminado translúcido. Enmarcada a inglete con perfil de aluminio anodizado "Mini" en color plata mate. Superficie magnética rotulable con rotuladores de borrado en seco. Incorpora elementos de fijación a pared y cajetín reposarotuladores.

## GLASSBOARD

**ENG.** Translucent laminated glass board equipped with matt silver anodized "Mini" aluminium frame and mitred corners. Magnetic surface is suitable for writing with dry wipe board markers. Wall-mounted brackets and pen tray included.

## TABLEAU EN VERRE

**FRA.** Tableau en verre laminé magnétique avec encadrement en aluminium anodisé "Mini" couleur argent. Surface pour feutre effaçables à sec, livré avec les éléments de fixation murale et un auget.





# 728/MC

PIZARRA DE CRISTAL DE COLORES  
GLASSBOARD - TABLEAU EN VERRE



## COLOR RAL



/AM /VD /RS /AZ /NJ /GR /MR  
1016 6019 3015 7035 2012 9006 1011

Consultar para colores especiales.

REF	L	H	⊠
<b>728/MC1</b>	60 x 80	2,3	30
<b>728/MC2</b>	80 x 100	2,3	30
<b>728/MC3</b>	100 x 120	2,3	30
<b>728/MC4</b>	100 x 150	2,3	30
<b>728/MC5</b>	100 x 175	2,3	30

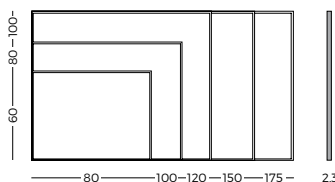

## PIZARRA DE CRISTAL DE COLOR

**ESP.** Pizarra de cristal laminado de color enmarcada a inglete con perfil de aluminio anodizado "Mini" en color plata mate. Superficie magnética rotulable con rotuladores de borrado en seco. Incorpora elementos de fijación a pared y cajetín reposarotuladores.

## COLOUR GLASSBOARD

**ENG.** Colour laminated glass board equipped with matt silver anodized "Mini" aluminium frame and mitred corners. Magnetic surface is suitable for writing with dry wipe board markers. Wall-mounted brackets and pen tray included.

## TABLEAU EN VERRE DE COULEUR

**FRA.** Tableau en verre de couleur laminé magnétique vec encadrement en aluminium anodisé "Mini" couleur argent. Surface pour feutre effaçables à sec, livré avec les éléments de fixation murale et un auget.

# 728

PIZARRA DE CRISTAL  
GLASSBOARD - TABLEAU EN VERRE



REF	L	H
728/1	45 x 60	0.3
728/2	60 x 90	0.3
728/3	90 x 120	0.3
728/4	100 x 150	0.3

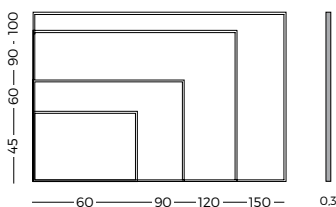

## PIZARRA DE CRISTAL

**ESP.** Pizarra magnética de cristal traslúcido sin marco de 3 mm de grosor. Superficie rotulable con rotuladores de borrado en seco. Incorpora elementos de fijación a pared y cajetín reposarrotuladores de 30 cm. junto a borrador especial y 5 imanes de neodimio.

## GLASSBOARD

**ENG.** Translucid 3 mm. thick magnetic glass board without frame. Surface is suitable for writing with dry wipe board markers. Wall-mounted brackets are included, as well as an eraser for glass surfaces, a 30 cm pen tray and 5 neodymium magnets

## TABLEAU EN VERRE

**FRA.** Tableau en verre magnétique sans profil de 3 mm d'épaisseur. surface pour feutre effaçables à sec, livré avec les éléments de fixation murale et auget, ainsi qu'un effaceur, un porte-marqueur de 30 cm et 5 aimants.



# 728/CO

PIZARRA DE CRISTAL DE COLORES  
COLOUR GLASSBOARD - TABLEAU EN VERRE DE COULEUR



## COLOR RAL



/AM /VD /RS /AZ /NJ /GR /MR  
1016 6019 3015 7035 2012 9006 1011

Consultar para colores especiales.

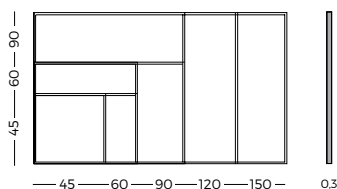

REF	L	H
<b>728/CO/1</b>	45 x 45	0.3
<b>728/CO/2</b>	45 x 60	0.3
<b>728/CO/3</b>	45 x 90	0.3
<b>728/CO/4</b>	60 x 60	0.3
<b>728/CO/5</b>	60 x 90	0.3
<b>728/CO/6</b>	90 x 90	0.3
<b>728/CO/7</b>	90 x 120	0.3
<b>728/CO/8</b>	90 x 150	0.3

**728/CO/A** Kit de accesorios



## PIZARRA DE CRISTAL DE COLOR

**ESP.** Pizarra magnética de cristal de colores sin marco de 3 mm de grosor. Superficie rotulable con rotuladores de borrado en seco. Incorpora elementos de fijación a pared. Kit de accesorios disponible: borrador para superficie de cristal y 5 imanes de neodimio.

## COLOUR GLASSBOARD

**ENG.** Colour 3 mm thick magnetic glass board without frame. Surface is suitable for writing with dry wipe board markers. Wall-mounted brackets are included. Accessories available: eraser and 5 neodymium magnets.

## TABLEAU EN VERRE DE COULEUR

**FRA.** Tableau en verre de couleur magnétique sans profil de 3 mm d'épaisseur. surface pour feutre effaçables à sec, livré avec les éléments de fixation murale. Accessoires disponibles: effaceur et 5 aimants.

# ZENIT

PIZARRA ZENIT DE ACERO VITRIFICADO/LAMINADA  
ENAMELLED/LAMINATED WHITEBOARD - TABLEAU ÉMAILLÉ/STRATIFIÉ



REF	L	H	RAIL
Z/720/1	60 x 80	2.3	30 -
Z/720/2	80 x 100	2.3	30 ✓
Z/720/3	100 x 120	2.3	30 ✓
Z/720/4	100 x 150	2.3	30 ✓
Z/720/5	100 x 175	2.3	30 ✓
Z/720/6	120 x 200	2.3	30 -
Z/720/7	120 x 250	2.3	30 -



REF	L	H	RAIL
Z/725/1	60 x 80	2.3	30 -
Z/725/2	80 x 100	2.3	30 ✓
Z/725/3	100 x 120	2.3	30 ✓
Z/725/4	120 x 150	2.3	30 ✓
Z/725/5	120 x 175	2.3	30 v
Z/725/6	120 x 200	2.3	30 -
Z/725/7	120 x 250	2.3	30 -

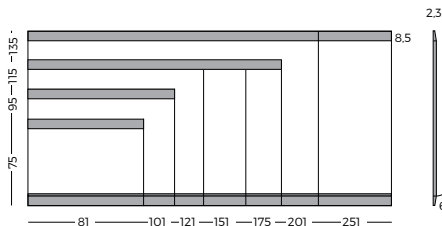

## PIZARRA ZENIT

**ESP.** Pizarra mural Zenit de acero vitrificado o laminada blanca. Enmarcada con perfil de aluminio anodizado en color plata mate. Superficie de acero vitrificado a 800°C con garantía de por vida. Rotulable en seco. Magnética. Incluye cajetín de 30 cm.

## ZENIT WHITEBOARD

**ENG.** Enamelled/laminated Zenit whiteboard. Equipped with silver anodized aluminium frame and plastic rounded corners. Surface enamelled at 800°C. Suitable for writing with dry wipe board markers. Magnetic. 30 cm tray included. Lifetime warranty.

## TABLEAU ZENIT

**FRA.** Tableau en acier émaillé ou stratiifié blanc. Encadrement en aluminium anodisé couleur argent aux coins arrondis en plastique. Surface émaillée vitrifiée à 800°C. Livré avec auget porte marqueurs de 30 cm. Magnétique. Garantie à vie.



### CUADRÍCULA

REF	L	H	AV
Z/720/C1	45 x 60	2,3	30
Z/720/C2	60 x 90	2,3	30
Z/720/C3	90 x 120	2,3	30
Z/720/C4	120 x 180	2,3	30



### PENTAGRAMA

REF	L	H	AV
Z/720/P1	120 x 150	2,3	30
Z/720/P2	120 x 200	2,3	30
Z/720/P3	120 x 300	2,3	30



### SOPORTE Y2

REF	L	H	AV
Z/720/Y2	190	100 x 80	53 30
Z/720/Y3	190	100 x 120	53 30
Z/720/Y4	190	100 x 150	53 30
Z/720/Y6	190	120 x 200	53 30

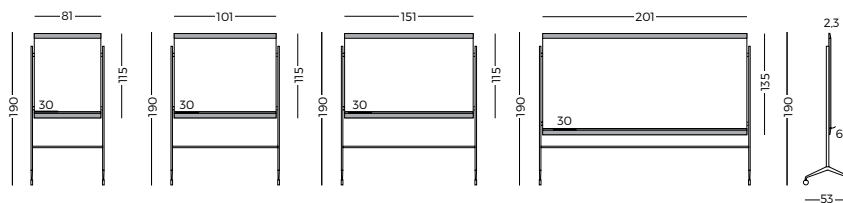

PS Capture  
App by Planning Sisplamo  
[www.planningsisplamo.com/pscapture](http://www.planningsisplamo.com/pscapture)



### ACCESORIOS

7006



7019



9002



# RAIL

SISTEMA DE RAIL  
RAIL SYSTEM - SYSTÈME RAIL

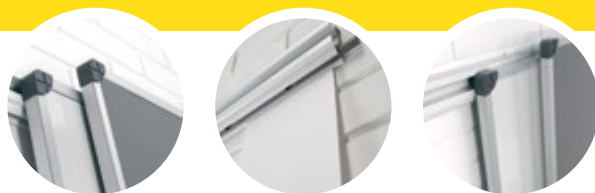

REF	↑	⇄
RP/000	-	8
RP/100	100	8
RP/200	200	8
RP/300	300	8

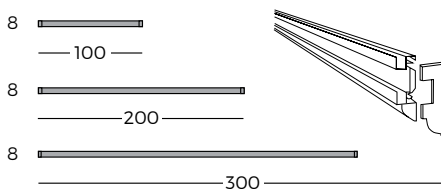

## SISTEMA DE RAIL

**ESP.** Rail plan es el sistema que mediante un perfil de aluminio lacado blanco, fijado a la pared, permite colgar en sus dos carriles, pizarras, tableros, etc.... desplazarlos longitudinalmente y hacer posible cualquier tipo de presentación, etc.

## RAIL SYSTEM

**ENG.** Rail's Plan lacquered aluminium profile fixed on a wall allows you to hang all types of boards and move them horizontally to help with your presentations and exhibitions. Below the lower rail you will find fittings suitable for hanging note pads, etc.

## SYSTÈME RAIL

**FRA.** Système de rail en aluminium en fixation murale pour superposer et faire coulisser des tableaux sur deux hauteurs de rail, idéal pour les présentations dans le bureau ou en salle de cours. Les documents seront soutenus par pression sous le rail.



### PIZARRA 720 - 725

pag. 14

REF	L	H	W	D
<b>720/2</b>	80 x 100	6	30	
<b>720/3</b>	100 x 120	6	30	
<b>720/4</b>	100 x 150	6	30	
<b>720/5</b>	100 x 175	6	30	
<b>725/3</b>	80 x 100	6	30	
<b>725/4</b>	100 x 120	6	30	
<b>725/5</b>	100 x 150	6	30	
<b>725/6</b>	120 x 175	6	30	



### PIZARRA ZENIT

pag. 26

REF	L	H	W	D
<b>Z/720/2</b>	80 x 100	6	30	
<b>Z/720/3</b>	100 x 120	6	30	
<b>Z/720/4</b>	100 x 150	6	30	
<b>Z/720/5</b>	100 x 175	6	30	



### TABLERO 760 - 765

pag. 86

REF	L	H	W	D
<b>760/2</b>	80 x 100	2,2	-	
<b>760/3</b>	100 x 120	2,2	-	
<b>760/4</b>	100 x 150	2,2	-	
<b>760/5</b>	100 x 175	2,2	-	
<b>765/2</b>	80 x 100	2,2	-	
<b>765/3</b>	100 x 120	2,2	-	
<b>765/4</b>	100 x 150	2,2	-	
<b>765/5</b>	120 x 175	2,2	-	

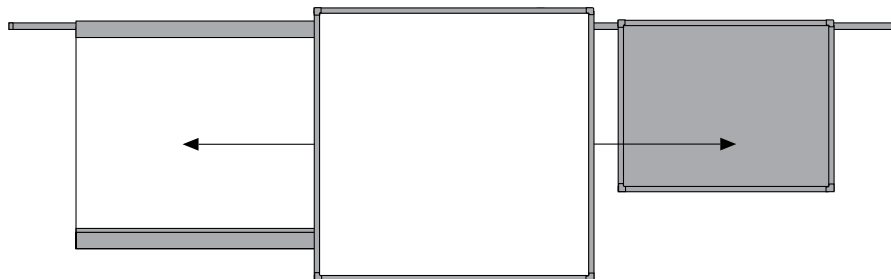
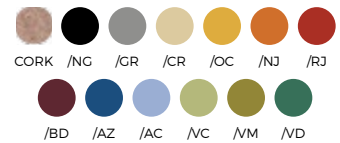

### ACCESORIOS PARA RAIL

#### RP/30

2,5	5



#### RP/L

5 x 8	90°

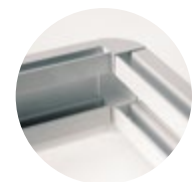

# SUPPORTS

SOPORTES DE PIÉ  
FLOOR SUPPORTS - PIÉTEMENTS



REF	↑	→	max
Y2/80/R Y2/80/N	173	53	80
Y2/120/R Y2/120/N	173	53	120
Y2/150/R Y2/150/N	173	53	150
Y2/175/R Y2/175/N	173	53	175
Y2/200/R Y2/200/N	173	53	200



**770/1** 174 53 120 x 200

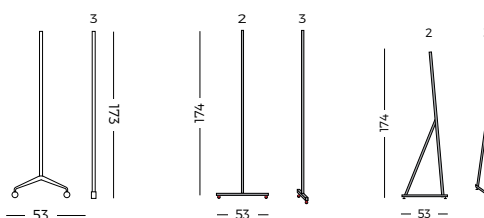

REF	↑	→	max
<b>770/2</b>	174	53	120 x 200



## SOPORTES

**ESP.** "Y2": Juego de soportes, fabricados en perfil de aluminio y pié de fundición. Incorpora ruedas con freno o niveladores. "T" + Delta: Juego de soportes metálicos, para adaptar pizarras, tableros, etc. Uso aconsejable hasta 2 metros de largo.

## SUPPORTS

**ENG.** "Y2" Set of 2 aluminium and cast-iron supports with castors or jacks for whiteboard. Suitable for all showcases, boards and panels. "T" support with 4 castors (2 of them with brakes). Recommended for lengths of up to 2 meters.

## PIÉTEMENTS

**FRA.** "Y2" Jeu de 2 piétements métalliques en aluminium et fonte. Livré avec roulettes (munies de freins). "T" + Delta : jeu de support métalliques pour adapter tableaux, vitrines... Taille recommandée du support jusqu'à 2m de large.





REF	↓	→	max
770/6	190	70	120 x 90

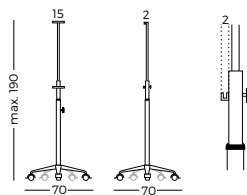

REF	↓	→	max
770/5	160	90	100 x 120

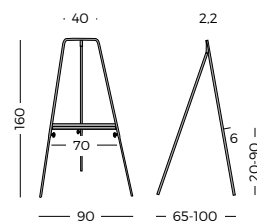

### SOPORTES

**ESP.** Soporte para tableros y pizarras fabricado con tubo metálico. Regulable en altura. La Ref. 770/6 incorpora de serie ruedas dotadas de freno. Medidas de 60 x 80 cm. hasta 100 x 120 cm.

### SUPPORTS

**ENG.** Support for cork boards and slates made with metal tube. Adjustable in height. Ref. 770/6 incorporates standard wheels with brake. Sizes between 60 x 80 cm. until 100 x 120 cm.

### PIÈTEMENTS

**FRA.** Support pour tableaux fabriqués avec tubes métalliques. Réglable en hauteur. La réf. 770/6 incorpore de série des roues dotées de frein. Mesures entre 60 x 80cm. en haut 100 x 120 cm.

# 720/D - 720/T

PIZARRA DÍPTICA/TRÍPTICA  
 DOUBLE/TRIPLE WHITEBOARD -  
 TABLEAU DYPTIQUE/TRYPHIQUE



REF				
<b>720/D1</b>	90 x 120	90 x 60	2+2	30
<b>720/D2</b>	120 x 180	120 x 90	2+2	30



REF				
<b>720/T1</b>	90 x 240	90 x 120	2+4	30
<b>720/T2</b>	120 x 400	120 x 200	2+4	30

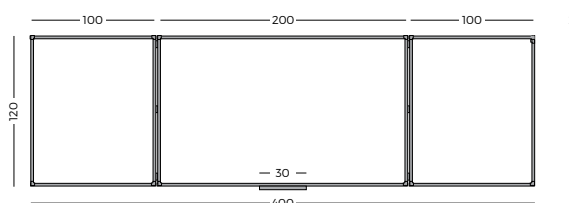
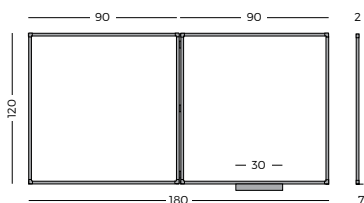

## PIZARRA DÍPTICA/TRÍPTICA

**ESP.** Pizarra blanca díptica o tríptica de acero vitrificado blanco. Enmarcada con perfil de aluminio anodizado en color plata mate y cantoneras redondeadas de plástico gris. Superficie de acero vitrificado a 800°C. Rotulable en seco. Magnética. Cajetín de 30 cm. incluido. 3 o 5 superficies de escritura.

## DOUBLE/TRIPLE WHITEBOARD

**ENG.** Double or triple enamelled whiteboard. Equipped with silver anodized aluminium frame and grey plastic rounded corners. Surface enamelled at 800°C. Suitable for writing with dry wipe board markers. Magnetic. 30 cm. pen tray included. 3 or 5 writing surfaces

## TABLEAU DYPTIQUE/TRYPHIQUE

**FRA.** Tableau diptyque ou triptyc blanc en acier émaillé. Cadre en aluminium anodisé couleur argent aux coins arrondis en plastique gris. Surface émaillée vitrifiée à 800°C. Effaçable à sec. Magnétique. Livré avec un auget de 30 cm. 3 ou 5 surfaces d'écriture.



# 720/X - 725/X

PIZARRA BLANCA VOLTEABLE  
REVOLVING WHITEBOARD - TABLEAU BLANC PIVOTANT



REF	↑	L	HT	□
<b>720/X1</b>	210	120 x 150	53	100
<b>720/X2</b>	210	120 x 175	53	100
<b>720/X3</b>	210	120 x 200	53	100



REF	↑	L	HT	□
<b>725/X1</b>	210	120 x 150	53	100
<b>725/X2</b>	210	120 x 175	53	100
<b>725/X3</b>	210	120 x 200	53	100

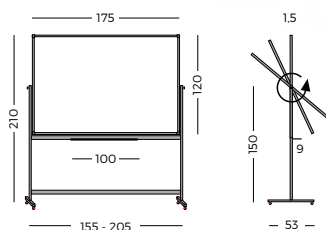

## PIZARRA VOLTEABLE

**ESP.** Pizarra volteable de doble cara laminada o de acero vitrificado. Enmarcada con perfil de aluminio anodizado en color plata mate y cantoneras redondeadas de plástico gris. Rotulable en seco. Estructura volteable metálica móvil provista de 4 ruedas, 2 de ellas con freno.

## REVOLVING WHITEBOARD

**ENG.** Revolving double sided enamelled or laminated whiteboard. Equipped with silver anodized aluminium frame and grey plastic rounded corners. Suitable for writing with dry wipe board markers. Metallic moveable support equipped with 4 castors, 2 of them with brakes.

## TABLEAU BLANC PIVOTANT

**FRA.** Tableau double surface émaillé ou stratifié blanc rotatif. Encadrement en aluminium anodisé argent aux coins arrondis en plastique gris. Monté sur piétement. Effaçable à sec. Support métallique équipé de 4 roulettes, donc 2 à freins.

# 720/VV

PIZARRA DE VAIVÉN  
VAIVÉN BOARD - TABLEAU VA-ET-VIENT

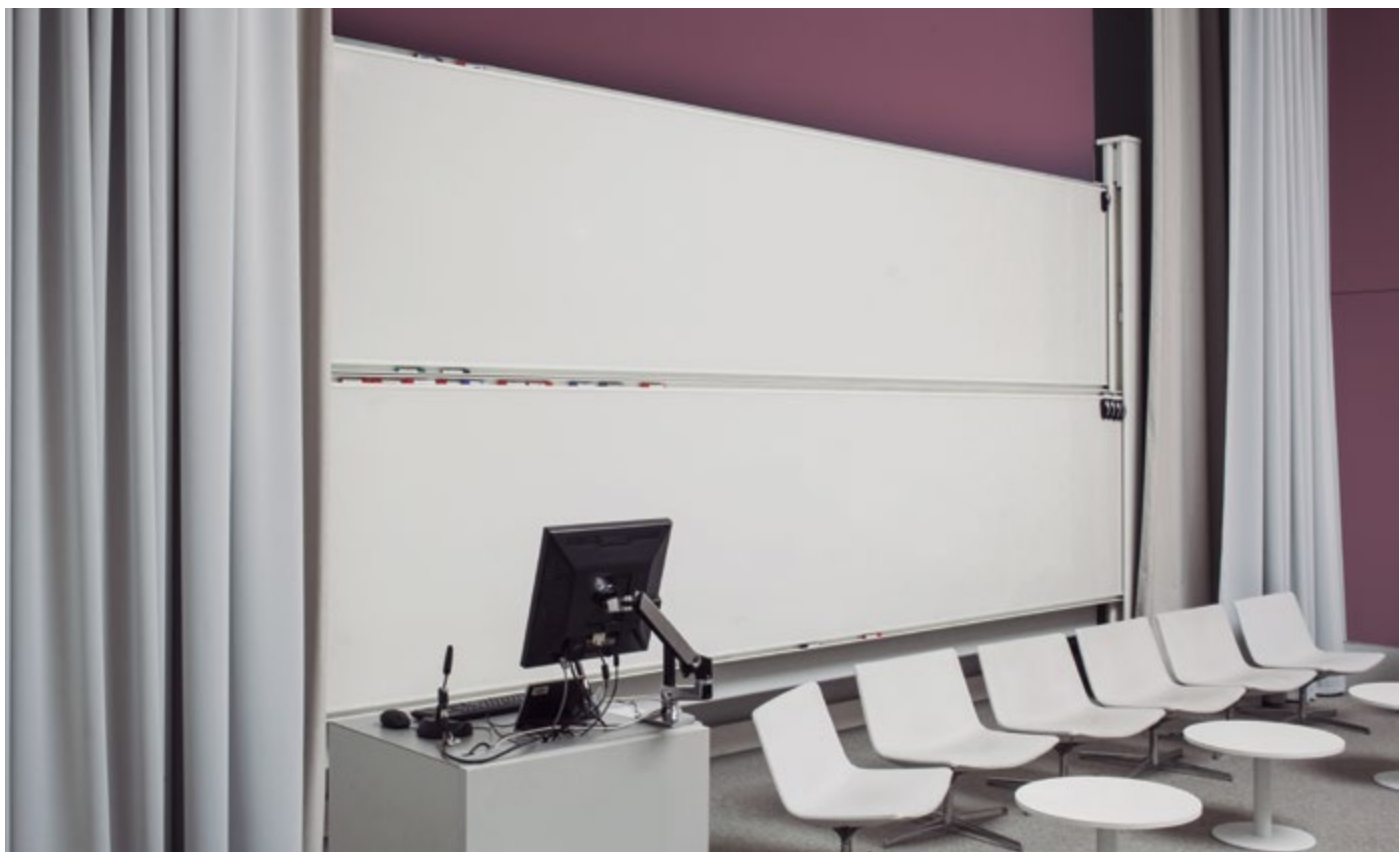

REF		L	H
720/2/VV1	x	120 x 200	12
720/2/VV2	x	120 x 250	12
720/2/VV3	x	120 x 300	12
720/2/VV4	x	120 x 400	12

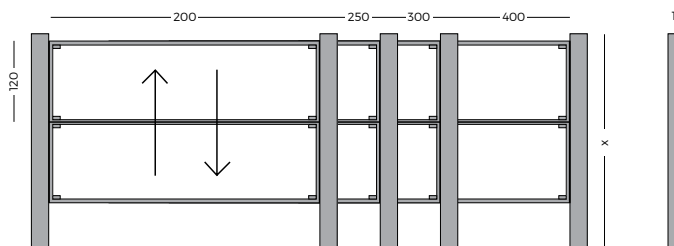

## PIZARRA VAIVÉN

**ESP.** Pizarra de acero vitrificado blanco sobre una estructura de aluminio anodizado en plata mate montada sobre suelo y pared. La pizarra se desliza y va guiada en el perfil por rodamientos de nylon. Ideales para colegios, universidades, anfiteatros...

## WHITEBOARD VAIVEN

**ENG.** Enamelled whiteboard mounted upon a supporting structure in silver anodized aluminium on stand or wall fixation. The surface slide is guided through a cable transmission. The ideal communication tool for large scale presentations, lecture theatres...

## TABLEAU VA-ET-VIENT

**FRA.** Tableau blanc émaillé monté sur une structure en aluminium anodisé couleur argent, fixation sol et mur. La surface se déplace sur le profil via des roulements. Pour une communication idéale dans les amphithéâtres, salles de congrès...



# 720/G

PIZARRA DE GUILLOTINA  
GUILLOTINE BOARD - TABLEAU GUILLOTINE

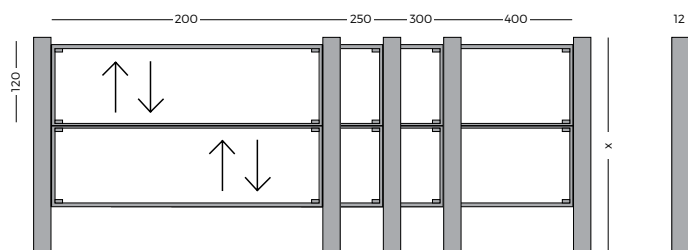

REF		L	H
720/2/G1	x	120 x 200	12
720/2/G2	x	120 x 250	12
720/2/G3	x	120 x 300	12
720/2/G4	x	120 x 400	12



## PIZARRA GUILLOTINA

**ESP.** Conjunto de 2 pizarras blancas de acero vitrificado sobre una estructura de aluminio anodizado en plata mate montadas sobre suelo y pared. Las pizarras son independientes entre sí, guiadas por rodamiento de nylon.

## GUILLOTINE BOARD

**ENG.** 2 enamelled whiteboards mounted upon a supporting structure in silver anodized aluminium on stand or wall fixation. Both writing surfaces slide vertically and are interdependent or each other. Guidance by nylon castors.

## TABLEAU GUILLOTINE

**FRA.** Ensemble de 2 tableaux blancs émaillés montés sur une structure en aluminium anodisé couleur argent, fixation sol et mur. Les deux surfaces se déplacent de façon indépendantes et sont guidées par des roulements.

# CHAMELEON SHARP

PIZARRA DE ACERO VITRIFICADO  
ENAMELLED WHITEBOARD - TABLEAU ÉMAILLÉ



REF	L	H
7201/10	58 x 88	1
7201/1	88 x 118	1
7201/2	88 x 178	1
7201/3	98 x 98	1
7201/4	98 x 148	1
7201/5	98 x 198	1
7201/6	118 x 148	1
7201/7	118 x 178	1
7201/8	118 x 238	1
7201/9	118 x 298	1

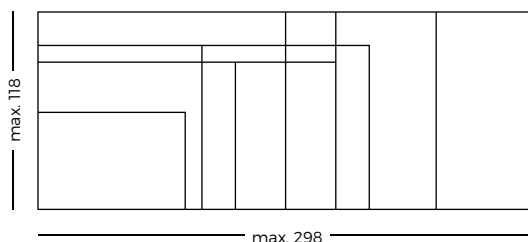

## PIZARRA CHAMELEON SHARP

**ESP.** Pizarra sin marco de 10 mm con borde lacado en blanco. Fabricado con acero vitrificado de doble capa de esmalte fundido a 800°C. El resultado es una superficie de escritura magnética, de borrado en seco. Sin poros, que evita la acumulación de tinta. Resistente a rayaduras y oxidación.

## CHAMELEON SHARP WHITEBOARD

**ENG.** Frameless rectangular whiteboard 10 mm panel with right-angled corners and white lacquered edges. Made of high-grade white enamelled steel (fired at 800°C). Magnetic and dry erasable. The surface is pore-free and mirror smooth. Ink has no chance to accumulate.

## TABLEAU CHAMELEON SHARP

**FRA.** Tableau rectangulaire sans cadre de 10mm d'épaisseur avec bord à angles droits laqués blanc. Surface en acier magnétique vitrifiée à 800°C. Effaçable à sec. Personnalisation disponible: toute forme et impression en couleur.



# CHAMELEON CURVE

PIZARRA DE ACERO VITRIFICADO  
ENAMELLED WHITEBOARD - TABLEAU ÉMAILLÉ

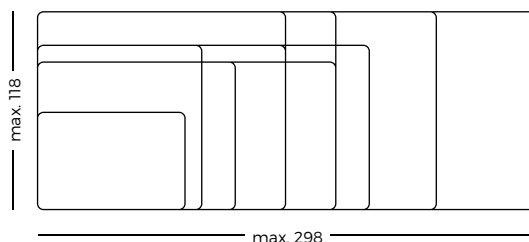
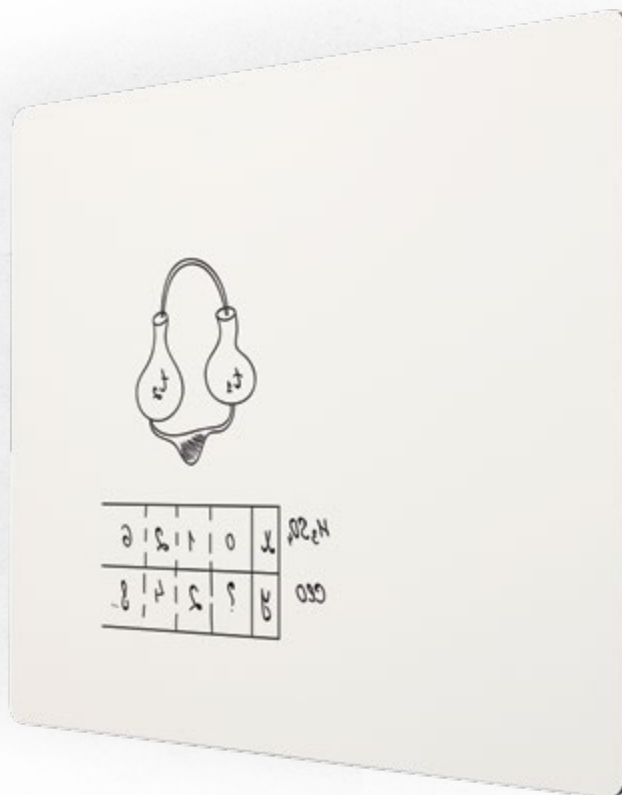

REF	L	H
<b>7202/10</b>	58 x 88	1
<b>7202/1</b>	88 x 118	1
<b>7202/2</b>	88 x 178	1
<b>7202/3</b>	98 x 98	1
<b>7202/4</b>	98 x 148	1
<b>7202/5</b>	98 x 198	1
<b>7202/6</b>	118 x 148	1
<b>7202/7</b>	118 x 178	1
<b>7202/8</b>	118 x 238	1
<b>7202/9</b>	118 x 298	1



## PIZARRA CHAMELEON CURVE

**ESP.** Pizarra rectangular sin marco de 10mm con borde redondeado lacado en negro. Superficie magnética de acero vitrificado a 800°C. Rotulable en seco. Personalización disponible: cualquier forma y impresión a todo color.

## CHAMELEON CURVE WHITEBOARD

**ENG.** Frameless rectangular whiteboard 10 mm panel with rounded corners and black lacquered edges. Made of high-grade white enamelled steel (fired at 800°C). Magnetic and dry erasable. Customization available: any shape and full-colour printed surface.

## TABLEAU CHAMELEON CURVE

**FRA.** Tableau rectangulaire sans cadre de 10mm d'épaisseur avec bord arrondi laqué noir. Surface en acier magnétique vitrifiée à 800°C. Effaçable à sec. Personnalisation disponible : toute forme et impression en couleur.

# CHAMELEON WALL

PIZARRA DE ACERO VITRIFICADO  
 ENAMELLED WHITEBOARD - TABLEAU ÉMAILLÉ



REF	L	H	PANELS
7201/I/W3	118 x 264	1	3
7201/I/W4	118 x 352	1	4
7201/I/W5	118 x 440	1	5
7201/S/W3	198 x 294	1	3
7201/S/W4	198 x 392	1	4
7201/S/W5	198 x 490	1	5

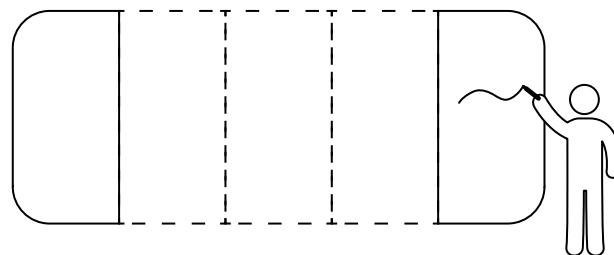

## PIZARRA CHAMELEON WALL

**ESP.** Pizarras de gran formato con diseño modular que encaja en cualquier posición. Crea una superficie prácticamente sin fisuras que puede adaptarse a las medidas de cualquier sala gracias a la unión de diferentes paneles con unión prácticamente invisible.

## WALL CHAMELEON WHITEBOARD

**ENG.** Broad whiteboards, very easy to link side by side or above each other. This creates an almost seamless whiteboard wall which can be tailored to the dimensions of your room thanks to its precise cut.

## TABLEAU WALL CHAMELEON

**FRA.** Tableau grand format avec une conception modulaire s'adaptant à n'importe quelle position. Superficie sans profil ni encadrement qui peut être adaptée aux mesures de n'importe quelle pièce grâce à l'union de différents panneaux avec une séparation presque invisible.



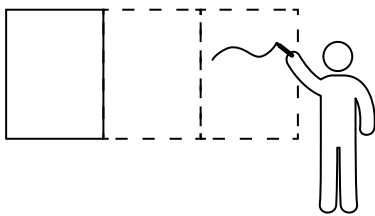
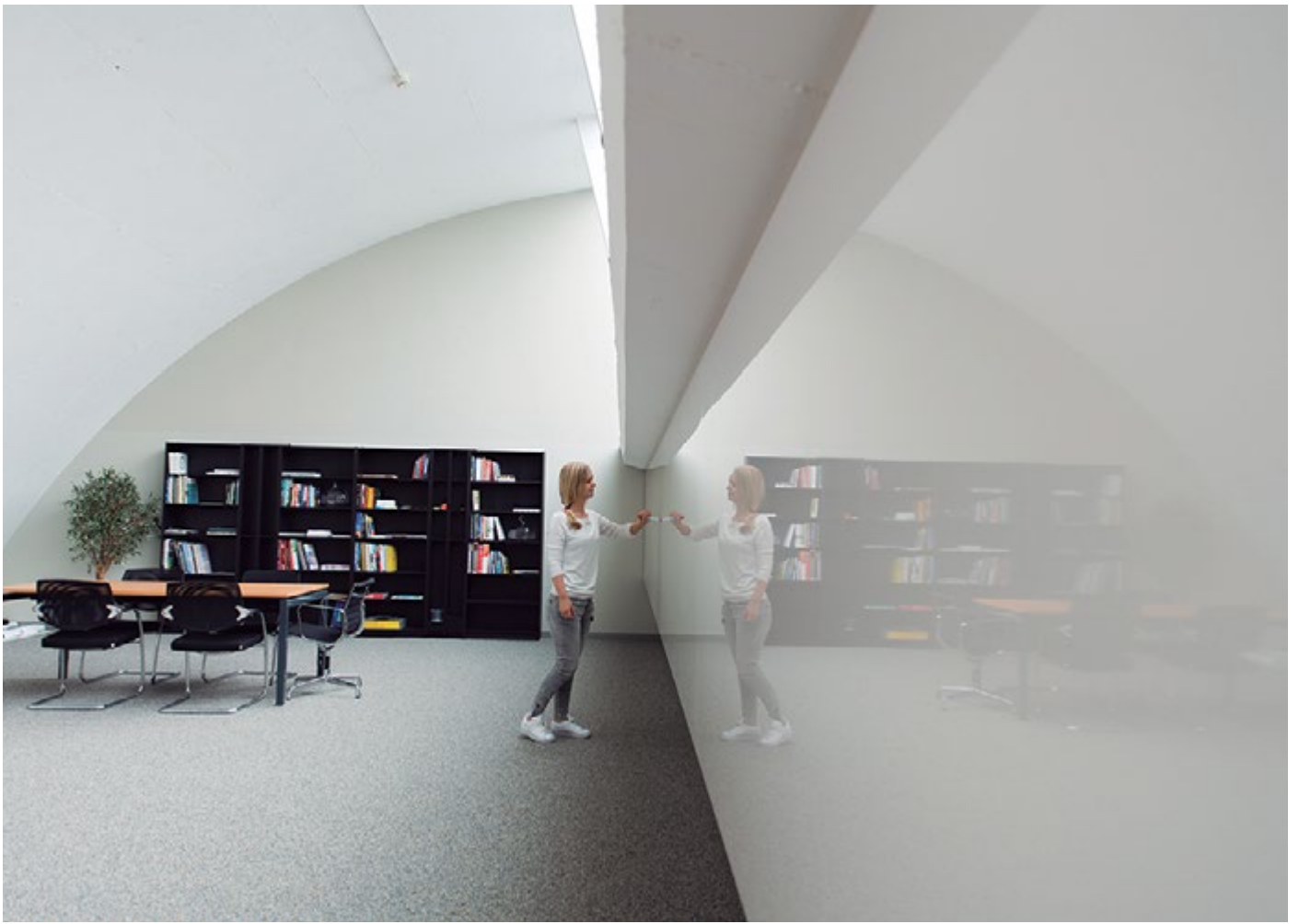

**REF**      L    H    **PANELS**  
**7201/1/W...**    118 x 88    1    1

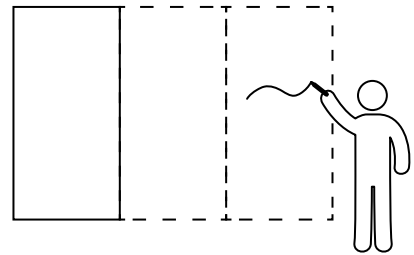

**REF**      L    H    **PANELS**  
**7201/5/W...**    198 x 98    1    1



# CHAMELEON SIX-SQUARE/ROUND

PIZARRA DE ACERO VITRIFICADO  
 ENAMELLED WHITEBOARD - TABLEAU ÉMAILLÉ

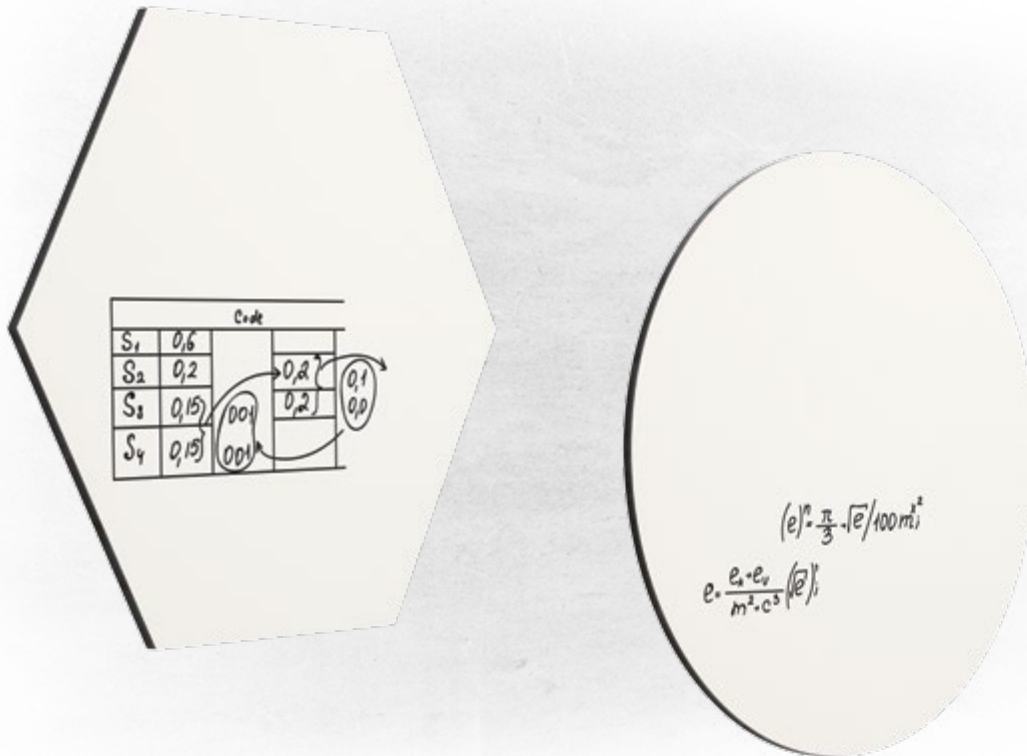

REF	L	-H-
7206/1	φ60	1
7206/2	φ98	1
7206/3	φ118	1



REF	L	-H-
7208/1	φ60	1
7208/2	φ98	1
7208/3	φ118	1

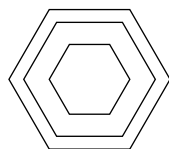

max. φ118

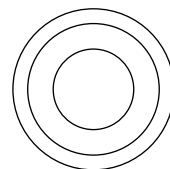

max. φ118

## PIZARRA CHAMELEON

**ESP.** Pizarra hexagonal o circular sin marco de 10mm con borde redondeado lacado en negro. Superficie magnética de acero vitrificado a 800°C. Rotulable en seco. Personalización disponible: cualquier forma y impresión a todo color.

## CHAMELEON WHITEBOARD

**ENG.** Frameless rectangular or round whiteboard 10 mm panel with rounded corners and black lacquered edges. Made of high-grade white enamelled steel (fired at 800°C). Magnetic and dry erasable. Customization available: any shape and full-colour printed surface.

## TABLEAU CHAMELEON

**FRA.** Tableau hexagonal ou rond sans cadre de 10mm d'épaisseur avec bord arrondi laqué noir. Surface en acier magnétique vitrifiée à 800°C. Effaçable à sec. Personnalisation disponible: toutes formes et impression en couleur.

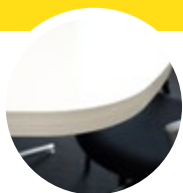

# CHAMELEON TABLE-TOP

TABLERO DE ACERO VITRIFICADO  
ENAMELLED TABLE-TOP - TABLEAU ÉMAILLÉ



REF	L	H
7210/1	180 x 90	2.5
7210/2	220 x 100	2.5
7210/3	298 x 118	2.5

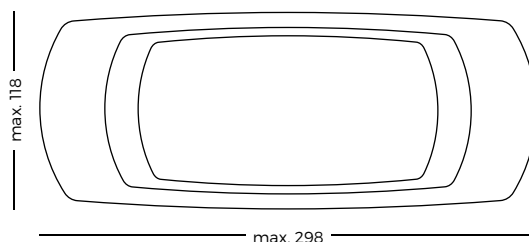

## TABLERO DE ACERO VITRIFICADO

**ESP.** Tablero de 2.5 cm de grosor para utilizar como mesa rotulable. Superficie magnética de acero vitrificado a 800°C, para un uso intensivo y constante. Rotulable en seco. Personalización disponible: cualquier forma y impresión a todo color. Patas no incluidas.

## ENAMELLED TABLE-TOP

**ENG.** Frameless rectangular board to use as table-top. Made of high-grade white enamelled steel (fired at 800°C). Magnetic and dry erasable. Customization available: any shape and full-colour printed surface. Legs not included.

## TABLE EN ACIER ÉMAILLÉ

**FRA.** Panneau de 2.5 cm d'épaisseur pour une utilisation comme table effaçable à sec. Surface en acier émaillé, magnétique, vitrifiée à 800°C, pour une utilisation intensive et constante. Personnalisation disponible: toutes formes et impression en couleur. Pieds non inclus.

# CHAMELEON CUSTOM

PIZARRA DE ACERO VITRIFICADO  
ENAMELLED WHITEBOARD - TABLEAU ÉMAILLÉ



REF	L	H	ACABADO
7200/M2/B	max. 118 x 298	1	Brillo
7200/M2/M	max. 118 x 298	1	Mate
7200/LOGO	Logo	-	-
7200/SKY	Skyline	-	-

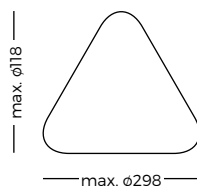

## PIZARRA CHAMELEON PERSONALIZADA

**ESP.** Pizarra de cualquier forma sin marco de 10mm. Superficie magnética de acero vitrificado a 800°C. Rotulable en seco. Diseño de una pieza ajustable a medida máxima de 118x298 cm.

## CHAMELEON CUSTOM WHITEBOARD

**ENG.** Frameless whiteboard 10 mm panel in any shape. Made of high-grade white enamelled steel (fired at 800°C). Magnetic and dry erasable. Each design must fit in a 118x298 rectangle.

## TABLEAU CHAMELEON PERSONNALISÉ

**FRA.** Tableau de toutes formes sans cadre de 10mm d'épaisseur avec bord arrondi laqué noir. Surface en acier magnétique vitrifiée à 800°C. Effaçable à sec. Conception d'une pièce ajustable aux dimensions maximum de 118x298 cm.



# CHAMELEON CUSTOM

PIZARRA DE ACERO VITRIFICADO  
ENAMELLED WHITEBOARD - TABLEAU ÉMAILLÉ



REF	L	ACABADO
7200/M2/B	max. 118 x 298	1 Brillo
7200/M2/M	max. 118 x 298	1 Mate
7200/LOGO	Logo	- -
7200/SKY	Skyline	- -

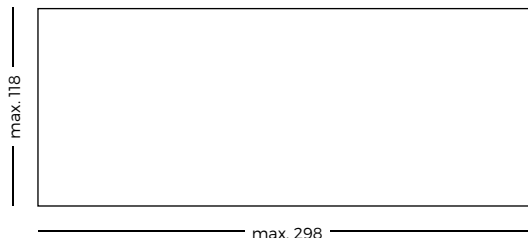

## PIZARRA CHAMELEON PERSONALIZADA

**ESP.** Crea una pizarra única. Posibilidad de cortar un logotipo en el interior o una silueta en la parte superior. Impresión a todo color en toda la superficie también disponible. Posibilidad de crear pizarras con calendarios, dibujos o logotipos.

## CHAMELEON CUSTOM WHITEBOARD

**ENG.** Multiple options to create your own unique whiteboard that no one else has. Have your own logo cut into the whiteboard or design a cutout at the top. Full colour printing is also an option on the whiteboard.

## TABLEAU CHAMELEON PERSONNALISÉ

**FRA.** Possibilité de créer votre propre tableau. Découper un logo à l'intérieur ou une silhouette sur le dessus. Impression en couleur sur toute la surface également disponible. Possibilité de créer des tableaux avec calendriers, designs et logos.



# CHAMELEON PROYECCIÓN

PIZARRA DE ACERO VITRIFICADO BLANCO MATE  
ENAMELLED MATT WHITEBOARD - TABLEAU ÉMAILLÉ MAT

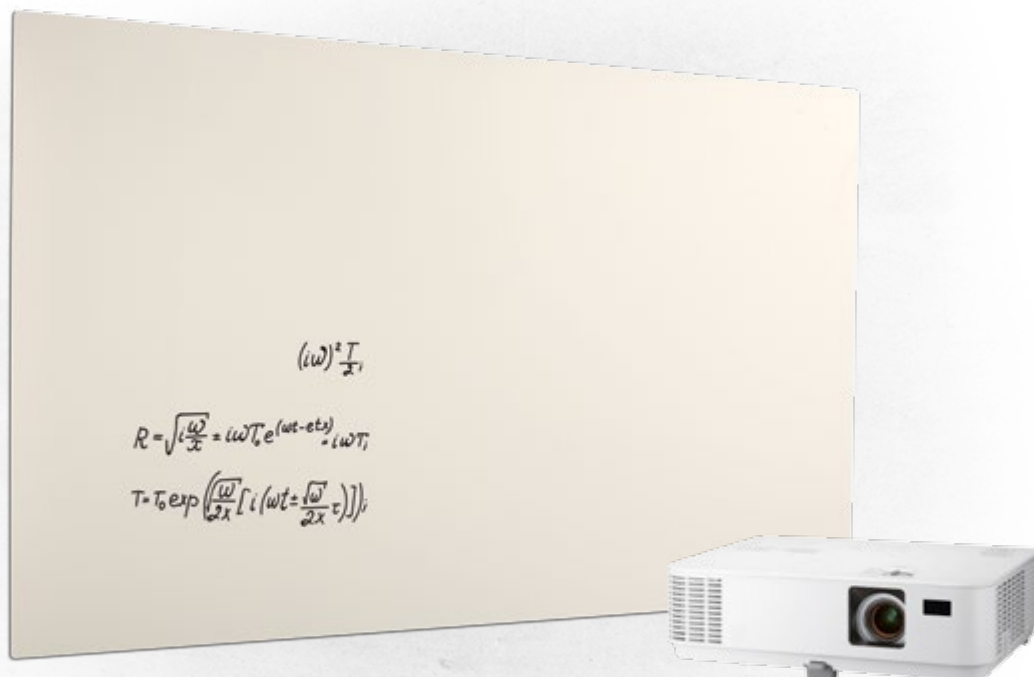

REF	L	H	m <sup>2</sup>	ACABADO
7200/M2/M	max. 118 x 298	1	1	Mate

REF	L	H
7201/6/M	118 x 148	1
7201/7/M	118 x 178	1
7201/8/M	118 x 238	1
7201/9/M	118 x 298	1

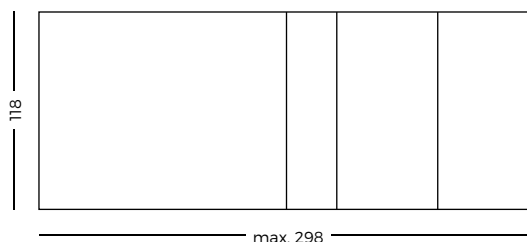

Projector no incluido  
Projector not included  
Projecteur non inclus



## PIZARRA CHAMELEON MATE

**ESP.** Pizarra mate sin marco de 10 mm con borde lacado en blanco. Fabricado con acero vitrificado de doble capa de esmalte fundido a 800°C. El resultado es una superficie de escritura magnética, de borrado en seco. Resistente a rayaduras y oxidación. Permite la proyección.

## CHAMELEON MATT WHITEBOARD

**ENG.** Matt frameless rectangular whiteboard 10 mm panel with right-angled corners and white lacquered edges. Made of high-grade white enamelled steel (fired at 800°C). Magnetic and dry erasable. Suited for projection.

## TABLEAU CHAMELEON MAT

**FRA.** Tableau blanc mate sans cadre de 10 mm d'épaisseur avec bord laqué blanc. Fabriqué en acier émaillé double émail cuite à 800°C. Le résultat est une surface d'écriture magnétique, effaçable à sec. Résistant aux rayures et à l'oxydation. La couleur blanc mate permet une projection de vos images et vidéos sans reflets.

# CHAMELEON MOBILE

PIZARRA MÓVIL DE ACERO VITRIFICADO  
 ENAMELLED MOBILE WHITEBOARD - TABLEAU MOBILE ÉMAILLÉ



REF L H  
 7215/1 192,3 x 88,6 53,9

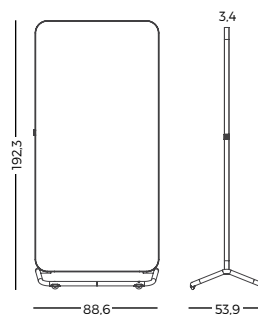

## COLORES



Consultar para colores especiales.

### PIZARRA CHAMELEON MÓVIL

**ESP.** Pizarra móvil, con superficie de acero vitrificado de doble capa de esmalte fundido a 800°C. Superficie de escritura sin poros, magnética, de borrado en seco. Estructura metálica con ruedas. Incluye tirador de cuero en el lateral de la pizarra para su transporte alrededor de la sala.

### CHAMELEON MOBILE WHITEBOARD

**ENG.** Mobile whiteboard, made from high-grade white enamelled steel (fired at 800°C). Magnetic and dry erasable. The surface is pore-free and mirror smooth. Metallic structure with casters. Includes handle for easy transportation.

### TABLEAU CHAMELEON MOBILE

**FRA.** Tableau mobile, surface en acier vitrifiée à 800°C. Effaçable à sec et magnétique. Surface sans pores et lisse. Structure métallique avec roulettes. Comprend une poignée pour un transport facile.





# CHAMELEON MOMENTUM

PIZARRA DE ACERO VITRIFICADO  
ENAMELLED WHITEBOARD - TABLEAU ÉMAILLÉ



## COLORES



/BL /AZ /GR

Consultar para colores especiales.

## REF

7216/1



190,4 x 75,7



70 x 130



2,5

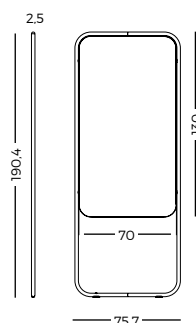

## PIZARRA CHAMELEON MOMENTUM

**ESP.** Pizarra portátil, de peso ligero. Superficie de acero vitrificado de doble capa de esmalte fundido a 800°C. Superficie de escritura sin poros, magnética, de borrado en seco. Estructura metálica.

## CHAMELEON MOMENTUM WHITEBOARD

**ENG.** Light weight portable whiteboard, made from high-grade white enamelled steel (fired at 800°C). Magnetic and dry erasable. The surface is pore-free and mirror smooth. Metallic structure.

## TABLEAU CHAMELEON MOMENTUM

**FRA.** Tableau portable, surface en acier vitrifiée à 800°C. Effaçable à sec et magnétique. Surface sans pores et lisse. Structure métallique.

# LEAN

PIZARRA DE ACERO VITRIFICADO LEAN  
 LEAN ENAMELLED WHITEBOARD - TABLEAU MOBILE LEAN



REF	720	L	H	□
1500/1	720/3	100 x 120	1,5	30
1500/2	720/4	100 x 150	1,5	30
1500/3	720/6	120 x 200	1,5	30

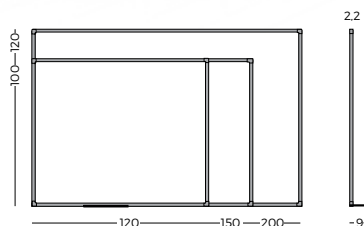

## PIZARRA LEAN DE ACERO VITRIFICADO

**ESP.** Pizarra de acero vitrificado blanco personalizada. Enmarcada con perfil de aluminio anodizado en color plata. Superficie de acero vitrificado a 800°C con garantía de por vida. Superficie magnética personalizable para implementar en fábricas, oficinas u organizar procesos. Consultar con la oficina técnica para su diseño personalizado.

## LEAN ENAMELLED WHITEBOARD

**ENG.** Whiteboard equipped with silver anodized aluminium frame and plastic rounded corners. Surface enamelled at 800°C. Customizable surface for use in factories, offices and for organizational processes. Consult our technical department for your custom design.

## TABLEAU ÉMAILLÉ LEAN

**FRA.** Tableau émaillé blanc avec encadrement en aluminium anodisé couleur argent aux coins arrondis en plastique. Surface magnétique émaillée vitrifiée à 800°C. Superficie personnalisable afin de l'implanter en usine, bureaux... Consultez nous pour un dessin personnalisé.

EJEMPLOS  
EXAMPLES - EXEMPLES

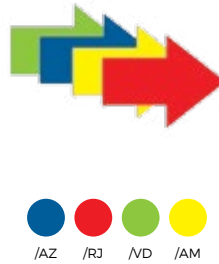

REF	L	U.	DISEÑO
KL/01	ø3.5	15 u. (5 x color)	emoji
KL/02	ø3.5	15 u. (5 x color)	tick
KL/03	ø3.5	15 u. (5 x color)	?
KL/04	ø3.5	15 u. (5 x color)	!
KL/11	ø5	5	emoji - doble cara
KL/12	ø5	5	tick - doble cara
KL/13	ø5	5	? - doble cara
KL/14	ø5	5	! - doble cara
KL/21	2 x 3	5	arrow →

REF	L	DIN	U.	DISEÑO
KL/A4	210 x 297	A4	5	Funda mag.
KL/A3	297 x 420	A3	5	Funda mag.



ACCESORIOS

**ESP.** Accesorios de diferentes colores y diseños para el uso con una pizarra LEAN. Ideal para marcar procesos completados u organizar tareas industriales. Productos disponibles: Pack de 15 imanes de 3 colores, de 5 imanes de doble cara, de 5 flechas en 4 colores o fundas DIN A4 o DIN A3 de colores.

ACCESORIES

**ENG.** Accessories in a selection of different colors and designs for use with a LEAN slate. Ideal for marking completed processes or organizing industrial tasks. Available products: pack of 15 3-color magnets, 5 double-sided magnets, 5 arrows in 4 colors or DIN A4 or DIN A3 colored.

ACCESOIRES

**FRA.** Accessoires de différentes couleurs et conceptions pour un usage sur tableau LEAN. Idéal pour lister ou marquer vos tâches et autres procédures. Produits disponibles: pack de 15 aimants de 3 couleurs, de 5 aimants doubles faces, de 5 flèches en 4 couleurs ou pochettes DIN A4 ou A3 de couleurs.

# FLIPCHARTS

PIZARRA DE CABALLETE  
FLIPCHART WHITEBOARD - CHEVALET TABLEAU



REF 704/N 190 100 x 80 90

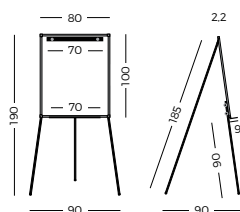

REF 711/N 180 100 x 70 70

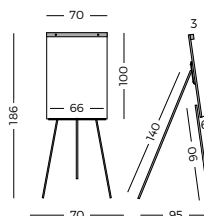

## PIZARRA CABALLETE

**ESP.** Pizarras de caballete lacadas de color blanco. Rotulable en seco. Soporte tipo trípode de diferentes diseños, ajustable en altura según apertura de la pata trasera. Soporte para blocs de papel incluido.

## FLIPCHART

**ENG.** Lacquered easel whiteboards with tripod type stand in different designs. Suitable for writing with dry wipe board markers. Magnetic. Support for paper flipcharts included. Height-adjustable.

## CHEVALET

**FRA.** Chevalet tableaux laqués blanc de différents designs et conceptions. Effaçable à sec. Magnétique. Support bloc papier inclus. Hauteur réglable.



**REF**    ↑    ↙    ⇄  
**709/E**    195    100 x 70    70



**REF**    ↑    ↙    ⇄  
**709/N**    181    100 x 68    95

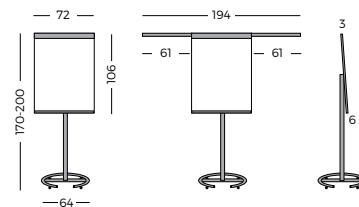
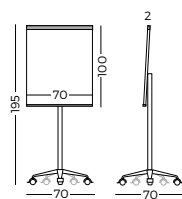

### PIZARRA DE PIÉ CON RUEDAS

**ESP.** Pizarras de pie con ruedas de diferentes cualidades y diseños. Superficie blanca magnética y brazos extensibles en ambos lados en la referencia 709/N. Soporte para blocs de papel incluido. Altura graduable.

### FLIPCHART ON CASTERS

**ENG.** Mobile white boards on casters in varied qualities and designs. Magnetic white surface and extendable arms on both sides in 709/N. Support for paper pads included. Adjustable height.

### CHEVALET AVEC ROULETTES

**FRA.** Chevalet tableau avec roue de différentes qualités et conceptions. Superficie blanche magnétique avec bras extensibles des deux côtés pour la version 709/N. Support bloc papier inclus. Hauteur réglable.

# 1000

PLANNING MAGNÉTICO  
MAGNETIC PLANNER - PLANNING MAGNÉTIQUE



REF L H

1000/50 90 x 120 1.5

1000/60 90 x 120 1.5

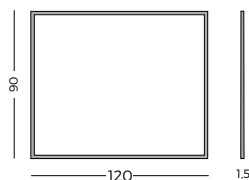

## PLANNING MAGNÉTICO

**ESP.** Pizarra para planning lacada blanca y con serigrafía. Rotulable con rotuladores de borrado en seco. Magnética. enmarcado con perfil de aluminio anodizado en color plata mate y cantoneras redondeadas grises. Incluye un cajetín reposarrotuladores de 30 cm.

## MAGNETIC PLANNER

**ENG.** Lacquered whiteboard with screen printed planner. Suitable for writing with dry wipe board markers. Magnetic. Equipped with silver anodized aluminium frame and grey plastic rounded corners. A 30 cm. pen tray included.

## PLANNING MAGNÉTIQUE

**FRA.** Tableau laqué blanc avec impression planning serigraphié. Encadrement en aluminium anodisé couleur argent aux coins arrondis en plastique gris. Effaçable à sec. Magnétique. Livré avec auget porte marqueurs 30 cm.



# VIDEOPROYECTORES

VIDEPROYECTORES  
PROJECTORS - VIDÉOPROJECTEURS



REF	CALIDAD	FUNCION.	ANSI LÚMEN	CONT.
<b>VPD/1</b>	Básico	Sobremesa	3000	10000:1
<b>VPD/2</b>	Profesional	Sobremesa	3300	6000:1
<b>VPD/3</b>	Profesional	Instalación	6000	20000:1
<b>VPD/4</b>	Profesional	Instalación	3300	10000:1
<b>VPD/5</b>	Standard	Sobremesa	3000	4000:1



## VIDEOPROYECTORES

**ESP.** Videoproyectores compactos y portátiles de altas prestaciones indicado para instalaciones o presentaciones móviles. Estos proyectores tienen un uso polivalente tanto para la educación como en empresas por su portabilidad. Ofrecen gran luminosidad.

## VIDEOPROJECTOR

**ENG.** Portable compact video projectors with high performance suitable for installations or mobile presentations. These projectors have a multipurpose use for education and for the company due to its portability, and offers high luminosity.

## VIDÉOPROJECTEURS

**FRA.** Gamme complète de vidéoprojecteurs polyvalent pour l'éducation et les entreprises. Performants, léger et très lumineux, vous y trouverez un produit adapté, une entrée, un moyen et un haut de gamme.



# SOPORTES 410

SOPORTES AJUSTABLES

ADJUSTABLE BRACKETS - SUPPORT PLAFOND INCLINABLE



REF	↑	↓
410/06/100	8/98	22
410/06	17	22

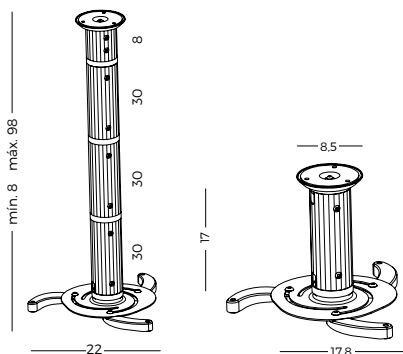

REF	↑	↓
410/20	20.3	73/123

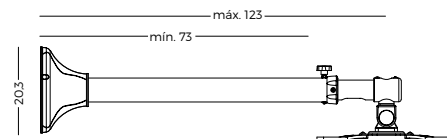

## SOPORTES AJUSTABLES

**ESP.** Soporte metálico de fijación a techo o pared para videoproyectores con un máximo de 12 kg. Acabado en color gris metalizado.

## ADJUSTABLE BRACKETS

**ENG.** Ceiling brackets for videoprojector up to 12 Kg. Suitable for most of the projectors thanks to 3 or 4 arms mounting pattern. Easy to install thanks to a hook-in system.

## SUPPORTS RÉGLABLES

**FRA.** Support métallique se fixant au plafond ou au sol pour vidéoprojecteurs jusqu'à 12 Kg. Finition gris métallisé.





# PANTALLAS

PANTALLA CON TRÍPODE  
SCREEN WITH TRIPOD - ÉCRAN DE PROJECTION



<b>REF</b>	L	I	H
<b>PT/T2</b>	180 x 180	270	13,5

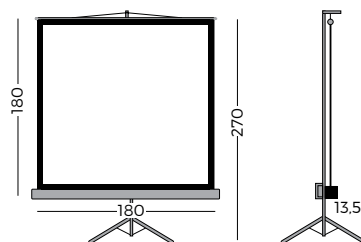

## PANTALLA CON TRÍPODE

**ESP.** Pantalla de proyección con trípode. La carcasa de gran diseño, está fabricada en chapa plastificada color blanco y la tela es especial antirreflectante. Posee brazo inclinable para corregir la distorsión de la imagen. Estructura plegable. Ganancia: 1,3. Tela M1.

## TRIPOD PROJECTOR SCREEN

**ENG.** Tripod projector screen. The design casing is made entirely of white laminated sheet metal and the fabric is antiglare. Easy to install and to use. The screen has an adjustable inclined bracket to correct image distortion. Foldable structure. Gain: 1.3. Fabric M1.

## ÉCRAN DE PROJECTION SUR PIED

**FRA.** Écran de projection sur trépied avec potence télescopique et correction de parallaxe. Carter en tôle plastifiée blanc non réfléchissant. Grande qualité d'image, la toile blanc mat de gain 1,3 est ignifugé M1. Déroulement simple et rapide à la mesure souhaitée.



# PANTALLAS

PANTALLA MURAL  
WALL PROJECTOR SCREEN - ÉCRAN DE PROJECTION



## PANTALLA

REF	—	—
PM/T2	177 x 177	14
PM/T3	200 x 200	14
PM/T4	240 x 240	14

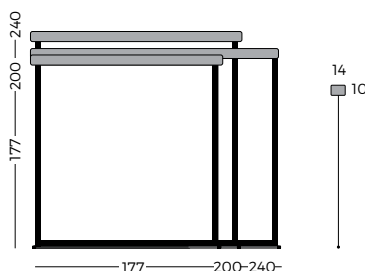

## SEPARADOR

REF	—
SP/1	1 - 15 cm.
SP/2	1 - 35 cm.



## PANTALLA DE PROYECCIÓN

**ESP.** Pantalla mural de proyección, adaptable a techo y pared. La carcasa está fabricada en chapa plastificada color blanco y la tela es especial antirreflectante. La tela se puede desenrollar a la medida deseada y el enrollado es automático. Ganancia: 1,3. Tela M1.

## PROJECTOR SCREEN

**ENG.** Projector screen for the ceiling and wall. The design casing is made entirely of white laminated sheet metal and the fabric is anti-glare. The fabric can be unrolled to the wished measurement and the rolling up is automatic. Gain 1,3. Fabric M1.

## ÉCRAN DE PROJECTION

**FRA.** Écran de projection manuel, fixation murale et/ou plafond. Carter en tôle plastifiée blanc non réfléchissant. Grande qualité d'image, la toile blanc mat de gain 1,3 est ignifugé M1. Déroulement simple et rapide à la dimension souhaitée.



# PANTALLAS ELÉCTRICAS

PANTALLA MURAL ELÉCTRICA  
ELECTRICAL PROJECTION SCREEN - ÉCRAN DE PROJECTION ÉLECTRIQUE



Mando a distancia incluido  
Remote control included  
Télécommande incluse

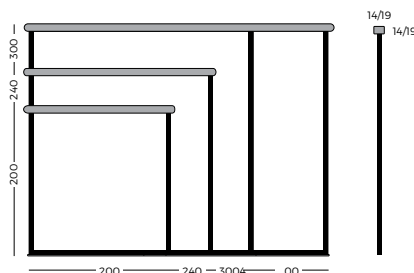

REF	□	⊥
PMM/12	200 x 200	14
PMM/13	240 x 240	19
PMM/14	300 x 300	19
PMM/15	300 x 400	19



## PANTALLA MURAL ELÉCTRICA

**ESP.** Pantalla mural de elevación automática por medio de un motor eléctrico adaptable a techo y pared. La carcasa está fabricada en aluminio y la tela es especial antirreflectante. El funcionamiento de la pantalla se acciona mediante un interruptor manual.

## ELECTRICAL PROJECTION SCREEN

**ENG.** Wall or ceiling projection screen. Roll-up mechanism driven through an electrical motor. The design casing is made entirely of aluminium and the fabric is anti-glare. A manual switch (included) or remote controls (optional). Gain 1.3. Fabric M1.

## ÉCRAN DE PROJECTION ÉLECTRIQUE

**FRA.** Écran de projection motorisée. Fixation murale ou plafond. Moteur à vitesse de rotation élevée, permettant une mise en place de l'écran très rapide. Carter en aluminium anodisé de couleur gris, anti-reflets Interrupteur manuel (inclus). Gain 1.3 est ignifugé M1.

# ACCESORIOS

ACCESORIOS  
ACCESORIES - ACCESSOIRES



**7015**

**ESP.** Borrador magnético "Design"  
**ENG.** Magnetic eraser "Design"  
**FRA.** Effaceur magnetique "Design"



**7015/1**

5 u.

**ESP.** Recambio para borrador 7015  
**ENG.** 7015 eraser felt refills  
**FRA.** Feutrines pour effaceur 7015



**7014**

**ESP.** Borrador de plástico  
**ENG.** Plastic eraser  
**FRA.** Effaceur en plastique



**7014/1**

2 u.

**ESP.** Recambio para borrador 7014  
**ENG.** 7014 eraser felt refills  
**FRA.** Feutrines pour effaceur 7014



**7006**

**ESP.** Borrador de aluminio magnético  
**ENG.** Magnetic eraser  
**FRA.** Effaceur magnetique



**7012**

**ESP.** Borrador de aluminio  
**ENG.** Eraser  
**FRA.** Effaceur



**7006/1**

20 u.

**ESP.** Recambio para borrador 7006 y 7012  
**ENG.** 7006 and 7012 eraser felt refills  
**FRA.** Feutrines pour effaceur 7006 et 7012



**7005 - 7005/12**

4 u. 12 u.

**ESP.** Rotuladores de pizarra  
**ENG.** Whiteboard markers  
**FRA.** Marqueurs effaçables à sec



**7008**

**ESP.** Aerosol para pizarras (200 ml)  
**ENG.** Whiteboard cleaner spray (200 ml)  
**FRA.** Aerosol pour tableau (200 ml)



**7019**

**ESP.** Portarrotuladores magnéticos  
**ENG.** Magnetics marker holder  
**FRA.** Porte marqueurs magnétique



**KIT/E**

**CONTIENE:**

4 Rotuladores  
Líquido limpiador 50ml.  
Borrador magnético OVAL  
Fielros recambio borrador  
Pack 10 imanes ø20mm.



**KIT/T**

**CONTIENE:**

4 Rotuladores  
Líquido limpiador 200 ml.  
Borrador magnético  
Fielros recambio borrador  
Pack 10 imanes ø20 mm.  
Reposa-rotuladores magnético



## PS Capture

App by Planning Sisplamo  
[www.planningsisplamo.com/pscapture](http://www.planningsisplamo.com/pscapture)



**7001** 25 u.

**ESP.** Bloc de papel liso 90 x 60 cm.  
**ENG.** Pad of plain paper 90 x 60 cm.  
**FRA.** Recharge papier uni 90 x 60 cm.



**7002/M**

**ESP.** Pinza portablocs magnética 6 x 65 cm.  
**ENG.** Magnetic pad holder 6 x 65 cm.  
**FRA.** Pince papier magnétique 6 x 65 cm.

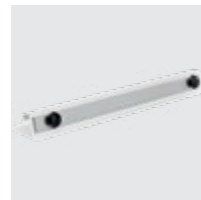

**7002**

**ESP.** Pinza portablocs 7 x 69 cm.  
**ENG.** Pad holder 7 x 69 cm.  
**FRA.** Pince papier 7 x 69 cm.



**7003 - 7003/30 - 7003/50**

**ESP.** Cajetín de 100, 30 ó 50 cm.  
**ENG.** 100, 30 or 50 cm. pen tray.  
**FRA.** Porte-marqueurs de 100, 30 ou 50cm.



**9002 - 9003 - 9004** 6 u.

**ESP.** Imanes redondos  $\phi 2$ ,  $\phi 2.5$ ,  $\phi 3.2$  cm.  
**ENG.** Round magnets  $\phi 2$ ,  $\phi 2.5$ ,  $\phi 3.2$  cm.  
**FRA.** Aimants ronds  $\phi 2$ ,  $\phi 2.5$ ,  $\phi 3.2$  cm.



**9010** 20 u.

**ESP.** Imanes redondos  $\phi 0.9$  cm.  
**ENG.** Round magnets  $\phi 0.9$  cm.  
**FRA.** Aimants ronds  $\phi 0.9$  cm.



**9011** 20 u.

**ESP.** Imanes cuadrados  $\phi 0.9$  cm.  
**ENG.** Square magnets  $\phi 0.9$  cm.  
**FRA.** Aimants carrés  $\phi 0.9$  cm.



**7011** 50 u.

**ESP.** Tiras adhesivas de 50 x 0,25 cm.  
**ENG.** Adhesive strips 50 x 0,25 cm.  
**FRA.** Bandes adhésives 50 x 0,25 cm.

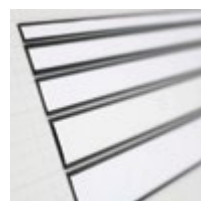

**9005 - 9006 - 9007 - 9008 - 9009**

**ESP.** Portarrótulos de 50 cm.  
**ENG.** 50 cm long magnetic title holder.  
**FRA.** Porte-étiquettes 50 cm.

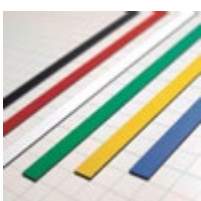
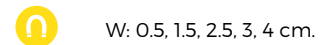

**9012 - 9014** W: 0.9, 1.2 cm.

**ESP.** Tiras magnética de 50 cm.  
**ENG.** Magnetic strips 50 cm.  
**FRA.** Bandes magnetique 50 cm.

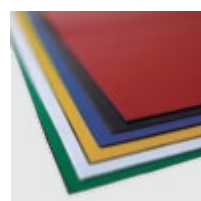

**9000**

**ESP.** Placa magnética de 50 x 60 cm.  
**ENG.** Magnetic plaque 50 x 60 cm.  
**FRA.** Plaque magnétique 50 x 60 cm.



# **ESCOLPLAN**

EQUIPAMIENTO ESCOLAR  
SCHOOL EQUIPEMENT  
EQUIPEMENT SCOLAIRE



# SUPERFICIES PS

SUPERFICIES DE ESCRITURA  
WRITTING SURFACES - SURFACE D'ÉCRITURE

## SUPERFÍCIE LAMINADA LAMINATED SURFACE - SURFACE STRATIFIÉE



**ESP.** Superficie de escritura verde en plancha laminada de alta presión (HPL). Extremadamente resistente a los impactos y desgaste. Fácil mantenimiento. No magnética.

**ENG.** Green writing surface in high pressure laminated board (HPL). Extremely resistant to impacts and usage. Easy maintenance. Not magnetic.

**FRA.** Superficie d'écriture vert en planche laminée à haute pression (HPL). Extrêmement résistante aux impacts et usure. Facile d'entretien. Non magnétique.



730 - ZENIT - 730/X

## SUPERFÍCIE DE ACERO VITRIFICADO ENAMELLED SURFACE - SURFACE ÉMAILLÉE



**ESP.** Superficie de color en acero vitrificado formada por una lámina central de acero de 0,7 mm cubierta con un revestimiento delgado de esmalte, que se funde con el acero a 800°C. Fabricado con un 30% de acero reciclado. Reciclable al 99,9%. Garantía de por vida. Resistente a rayaduras, abrasión, productos químicos, fuego, bacterias y graffitis. Fácil mantenimiento. Mayor contraste de color. Visibilidad mejorada y óptima comodidad visual. Magnética.

**ENG.** Coloured surface in vitrified steel formed by a 0.7 mm steel core sheet covered with a thin coating of enamel, which melts with the steel at 800 ° C. Made with 30% recycled steel. Recyclable at 99.9%. Lifetime warranty. Resistant to scratches, abrasion, chemicals, fire, bacteria and graffiti. Easy maintenance. Higher color contrast. Improved visibility and optimum visual comfort. Magnetic.

**FRA.** Superficie de couleur en acier vitrifié formé par une tôle d'acier de 0,7mm recouverte d'un revêtement émaillé fondu à 800°C. Fabriqué avec 30% d'acier recyclé. Recyclable à 99,9%. Garantie à vie. Résistant aux rayures, abrasion, produits chimiques, feu, bactéries et graffitis. Facile d'entretien. Grand contraste de couleur. Visibilité améliorée et qualité visuel optimum. Magnétique.



730/A - 730/C - 730/P - 734 - ZENIT - 730/D  
730/T - 730/A/X - 739 - 730/VV - 730/G



La superficie e3 CeramicSteel es la única del sector a nivel mundial con la certificación:  
**Cradle to Cradle Certified TM Bronze**

Norma ISO 9001





## COLORES DE LA SUPERFICIE SURFACES COLOURS - COULEURS DE SURFACE

**ESP.** Colores disponibles para pizarras Escolplan de Planning Sislamo. Ideal para la escritura en tizas de colores o rotuladores de tiza líquida.

**ENG.** Colours available colors for Escoplan plan boards of Planning Sislamo. Ideal for writing with colored chalks or liquid chalk markers.

**FRA.** Couleurs disponibles pour tableaux Escolplan de Planning Sislamo. Idéal pour l'écriture à la craie de couleurs ou feutre de craie liquide.

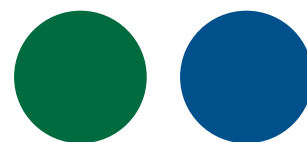

RAL 6028

RAL 5023



RAL 7015

RAL 7012

## PERFIL DE LA SUPERFICIE SURFACES PROFILE - PROFIL DE SURFACE

**ESP.** Los perfiles que enmarcan las pizarras de Planning Sislamo son de aluminio anodizado. Las cantoneras, que ocultan el tornillo, son piezas fabricadas por inyección de ABS.

**ENG.** The profiles framing Planning Sislamo white boards are anodized aluminum. The corners, which conceal the screw, are manufactured by injection ABS.

**FRA.** Les profiles qui encadrent les tableaux Planning Sislamo sont en aluminium anodisé. Les coins, qui cachent la fixation, sont des pièces fabriquée par injection d'ABS.

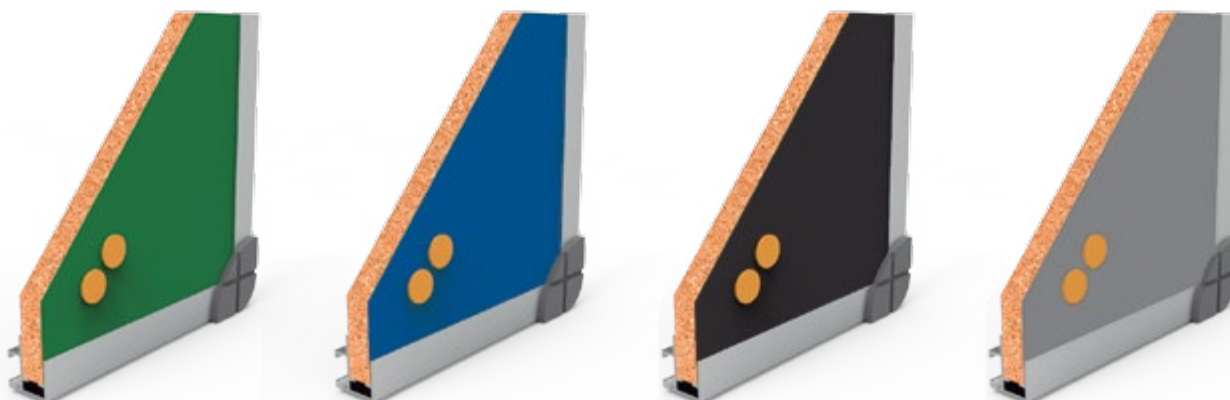
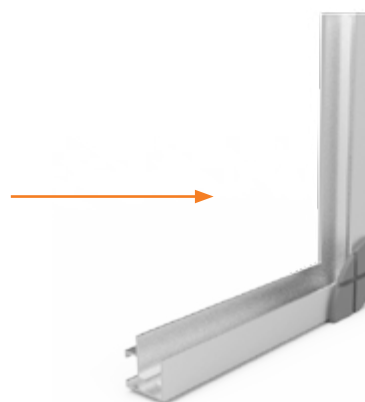

# GUÍA PS

ESCOGE TU PIZARRA

CHOOSE YOUR WHITEBOARD - CHOISIR VOTRE TABLEAU

**2-20**

AULA PEQUEÑA

**+20**

AULA GRANDE

## AULA PEQUEÑA CLASSROOM - ÉCOLE

**ESP.** Pizarras de uso personal para el uso en el hogar o en salas de pequeñas dimensiones. Disponibles en versión mural, con soportes, en diferentes materiales y colores.

**ENG.** Whiteboards for use in the home or in small rooms. Available in mural version, with supports, in varied materials and many colors.

**FRA.** Tableau à usage personnel pour la maison ou de petites pièces/bureaux.. Disponible en version murale, avec support et en différents matériaux et couleurs.

- **730**
- 730/A
- **730/C**
- **730/P**
- ZENIT
- 730/X
- 730/A/X

## AULA GRANDE CLASSROOM - ÉCOLE

**ESP.** Pizarras para uso en escuelas, universidades o centros de enseñanza, con una altura de 120 cm y longitud variable. Se recomienda el uso de este tipo de pizarras debido a su medida ergonómica: tanto el punto superior como inferior coinciden con el punto de máxima extensión del brazo. Disponibles en versión mural, con soportes, en diferentes materiales y colores.

**ENG.** White boards for use in schools, universities or teaching , with a height of 120 cm and variable length. The use of this type of board is recommended due to its ergonomic measurement: both the upper and lower points coincide with the point of maximum extension of the arm. Available in mural version, with supports, in different materials and colours.

**FRA.** Tableaux pour usage en écoles, universités ou centres d'enseignement, avec une hauteur de 120 cm et longueur variable. Il est recommandé l'usage de ce type de tableaux pour leur dimensions ergonomiques: le point supérieurs et inférieure coincide avec le point maximum d'extension du bras. Disponibles en version murale, avec supports, en différents matériaux et couleurs.

- **730/A**
- ZENIT
- 730/X
- 730/A/X
- 730/D
- 730/T
- **730/VV**
- **730/C**

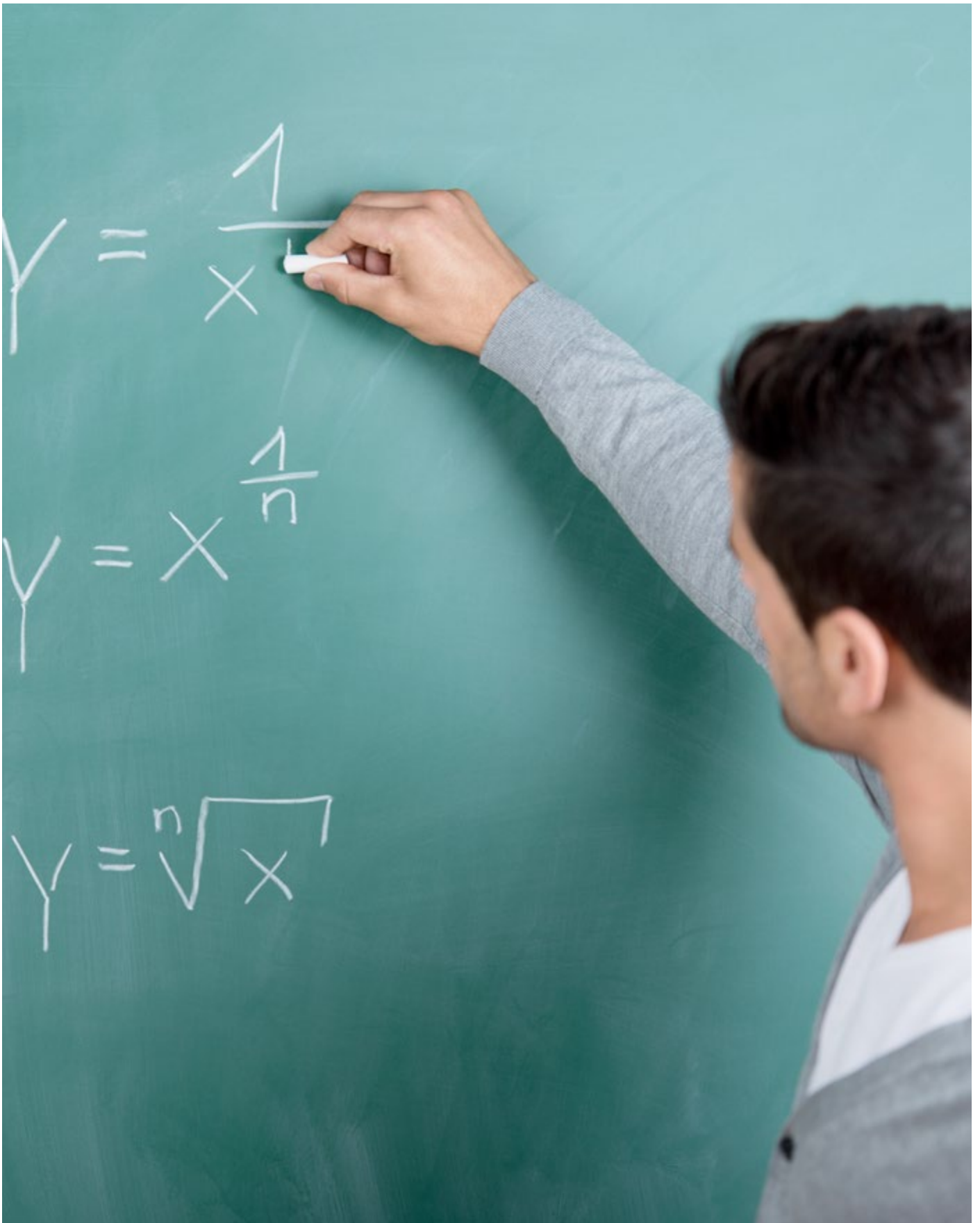

# 730

PIZARRA LAMINADA  
LAMINATED CHALK BOARD - TABLEAU STRATIFIÉ



REF	L	H	RAIL
730/11	40 x 60	2.2	30 -
730/12	60 x 80	2.2	30 -
730/1	80 x 120	2.2	30 ✓
730/2	100 x 120	2.2	30 ✓
730/3	120 x 150	2.2	30 ✓
730/4	120 x 200	2.2	30 -
730/5	120 x 250	2.2	30 -
730/6	120 x 300	2.2	30 -
730/7*	120 x 350	2.2	30 -
730/8*	120 x 400	2.2	30 -
730/9*	120 x 500	2.2	30 -
730/10*	120 x 600	2.2	30 -

\* Fabricado en dos piezas  
Made from 2 pieces  
Fabriqué en 2 pièces

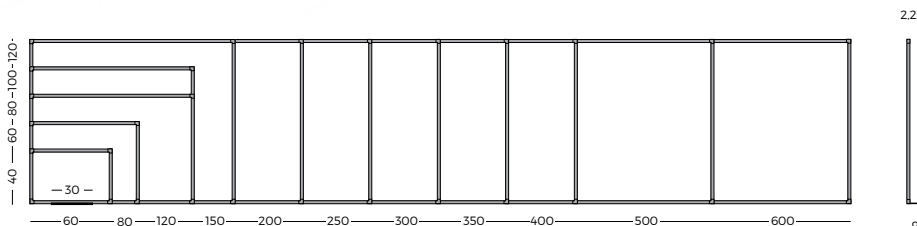

## PIZARRA LAMINADA

**ESP.** Pizarra laminada verde. Superficie laminada en alta presión. Enmarcada con perfil de aluminio anodizado en color plata mate y cantoneras redondeadas de plástico gris. Escritura con tiza. Incluye cajetín reposarrotuladores de 30 cm.

## LAMINATED CHALKBOARD

**ENG.** High-pressure laminated chalkboard. Equipped with silver anodized aluminium frame and grey plastic rounded corners. Suitable for writing with chalk. A 30 cm. pen tray included.

## TABLEAU STRATIFIÉ

**FRA.** Tableau stratifié vert. Encadrement en aluminium anodisé couleur argent aux coins arrondis en plastique gris. Surface pour écriture à la craie. Livré avec un auget porte marqueurs de 30 cm.



### SOPORTE T

REF	↑	L	⇄	□
736/L	190	120 x 150	53	30
737/L	190	120 x 200	53	30



### SOPORTE DELTA

REF	↑	L	⇄	□
738/L	190	120 x 150	53	30
739/L	190	120 x 200	53	30



### SOPORTE Y2

REF	↑	L	⇄	□
+ Y2/120	190	100 x 120	53	30
+ Y2/150	190	120 x 150	53	30
+ Y2/200	190	120 x 200	53	30

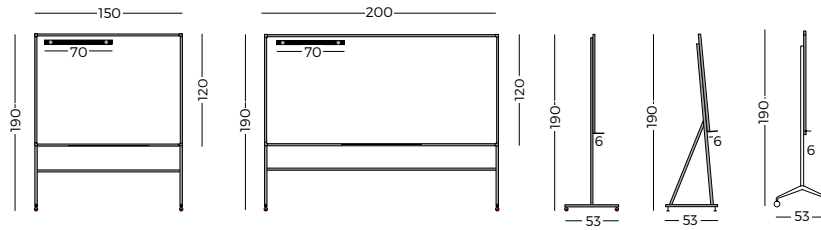

## PS Capture

App by Planning Sislamo  
[www.planningsislamo.com/pscapture](http://www.planningsislamo.com/pscapture)



### ACCESORIOS

7006



7014



7008



# 730/A

PIZARRA DE ACERO VITRIFICADO  
ENAMELLED CHALK BOARD - TABLEAU EMAILLÉ



REF	L	H	RAIL	
730/A1	120 x 100	2.2	30	✓
730/A2	120 x 150	2.2	30	✓
730/A3	120 x 200	2.2	30	-
730/A4	120 x 250	2.2	30	-
730/A5	120 x 300	2.2	30	-
730/A6	120 x 400	2.2	30	-



## COLOR

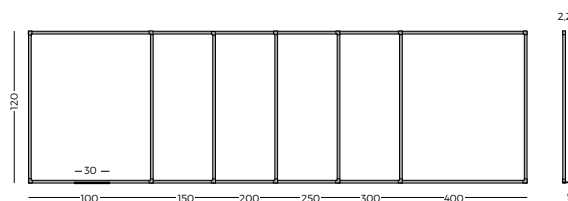

### PIZARRA DE ACERO VITRIFICADO

**ESP.** Pizarra mural de acero vitrificado verde. Enmarcada con perfil de aluminio anodizado en color plata mate. Superficie de acero vitrificado a 800°C con garantía de por vida. Escritura con tiza. Magnética. Incluye cajetín de 30 cm.

### ENAMELLED CHALKBOARD

**ENG.** Enamelled chalkboard. Equipped with silver anodized aluminium frame and plastic rounded corners. Surface enamelled at 800°C. Suitable for writing with chalk. Magnetic. 30 cm en tray included. Lifetime warranty on the writing surface.

### TABLEAU EMAILLÉ

**FRA.** Tableau émaillé vert. Encadrement en aluminium anodisé couleur argent aux coins arrondis en plastique. Surface émaillée vitrifiée à 800°C. Livré avec auget porte marqueurs de 30 cm. Magnétique. Superficie garantie à vie. Surface pour écriture à la craie.



### SOPORTE T

REF	↑	└┘	┆┆	┆
<b>736/A</b>	190	120 x 150	53	30
<b>737/A</b>	190	120 x 200	53	30



### SOPORTE DELTA

REF	↑	└┘	┆┆	┆
<b>738/A</b>	190	120 x 150	53	30
<b>739/A</b>	190	120 x 200	53	30



### SOPORTE Y2

REF	↑	└┘	┆┆	┆
<b>+ Y2/120</b>	190	100 x 120	53	30
<b>+ Y2/150</b>	190	120 x 150	53	30
<b>+ Y2/200</b>	190	120 x 200	53	30

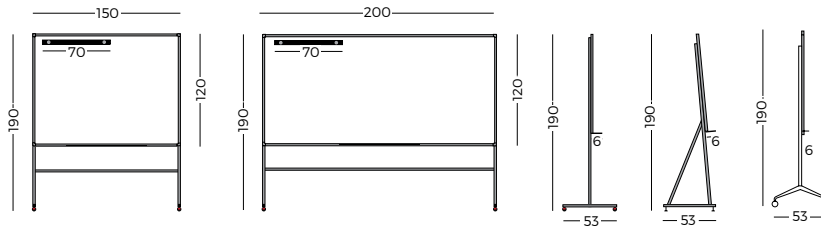

## PS Capture

App by Planning Sislamo  
[www.planningsislamo.com/pscapture](http://www.planningsislamo.com/pscapture)



### ACCESORIOS

7006



7013/C



7013/B



# 730/C-730/P

PIZARRA DE ACERO VITRIFICADO CON CUADRICULA/PENTAGRAMA  
 GRID/PENTAGRAM - QUADRILLÉ/PENTAGRAMME

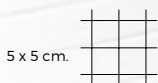
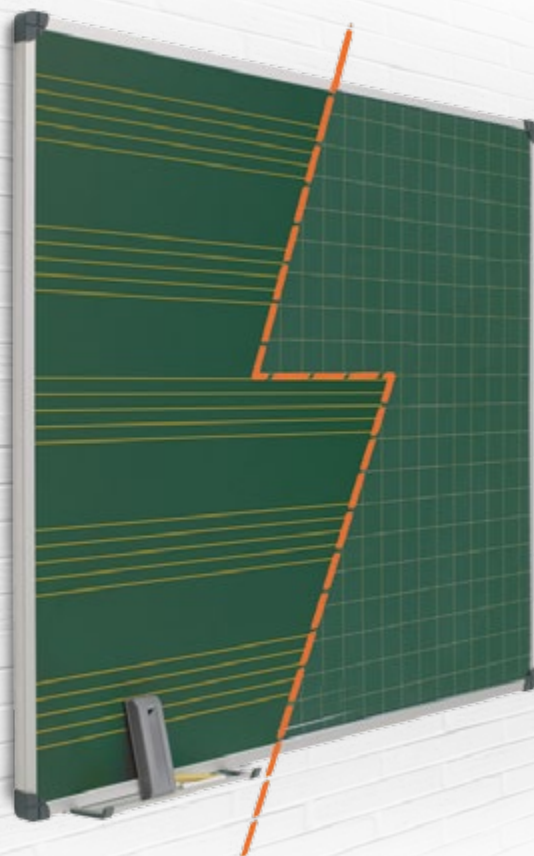
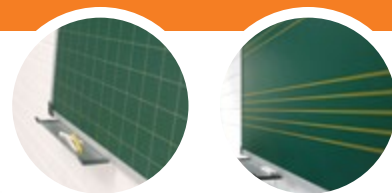

REF	L	H	RAIL
<b>730/A/C1</b>	100 x 120	2.2	30 ✓
<b>730/A/C2</b>	120 x 150	2.2	30 ✓
<b>730/A/C3</b>	120 x 200	2.2	30 -
<b>730/A/C4</b>	120 x 300	2.2	30 -

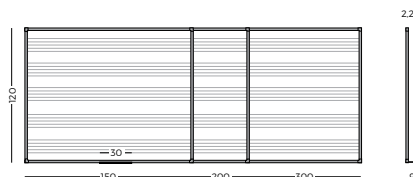
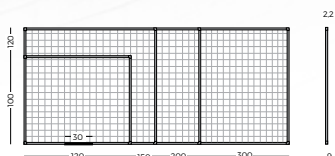

REF	L	H	RAIL
<b>730/A/P1</b>	120 x 150	2.2	30 ✓
<b>730/A/P2</b>	120 x 200	2.2	30 -
<b>730/A/P3</b>	120 x 300	2.2	30 -



## PIZARRA CUADRICULADA/PENTAGRAMA

**ESP.** Pizarra mural de acero vitrificado verde con cuadrícula o pentagrama. Enmarcada con perfil de aluminio anodizado en color plata mate. Superficie de acero vitrificado a 800°C con garantía de por vida. Escritura con tiza. Magnética. Incluye cajetín de 30 cm.

## GRIDED/PENTAGRAM WHITEBOARD

**ENG.** Enamelled grided or pentagram chalkboard. Equipped with silver anodized aluminium frame and plastic rounded corners. Surface enamelled at 800°C. Suitable for writing with chalk. Magnetic. 30 cm en tray included. Lifetime warranty on the writing surface.

## TABLEAU QUADRILLÉ/PENTAGRAMME

**FRA.** Tableau émaillé vert quadrillé ou pentagramme Encadrement en aluminium anodisé couleur argent aux coins arrondis en plastique. Surface émaillée vitrifiée à 800°C. Livré avec auget porte marqueurs de 30 cm. Magnétique. Superficie garantie à vie. Surface pour écriture à la craie.





### SOPORTE T

REF	↑	L	⇄	□
<b>730/AC/T2</b>	190	120 x 150	53	30
<b>730/AC/T3</b>	190	120 x 200	53	30
<b>736/A/P2</b>	190	120 x 150	53	30
<b>737/A/P3</b>	190	120 x 200	53	30



### SOPORTE DELTA

REF	↑	L	⇄	□
<b>730/AC/D2</b>	190	120 x 150	53	30
<b>730/AC/D3</b>	190	120 x 200	53	30
<b>738/A/P2</b>	190	120 x 150	53	30
<b>739/A/P3</b>	190	120 x 200	53	30



### SOPORTE Y2

REF	↑	L	⇄	□
<b>+ Y2/150</b>	190	120 x 150	53	30
<b>+ Y2/200</b>	190	120 x 200	53	30

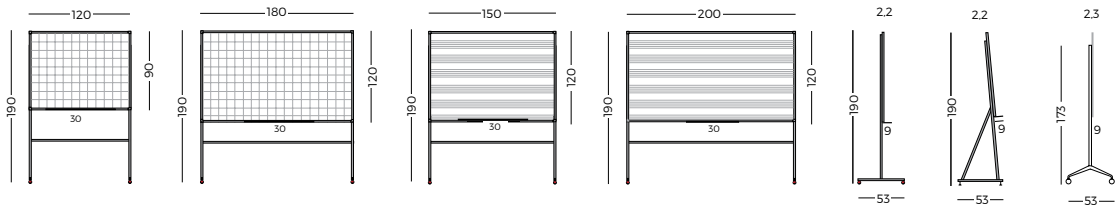

## PS Capture

App by Planning Sislamo  
[www.planningsislamo.com/pscapture](http://www.planningsislamo.com/pscapture)



### ACCESORIOS

7006



7013/C



7013/B



# 734

PIZARRA DE ACERO VITRIFICADO CON MARCO 'MINI'  
WHITEBOARD 'MINI' - TABLEAU 'MINI'



REF	L	H	RAIL	
734/10	40 x 60	2.2	30	-
734/1	60 x 80	2.2	30	-
734/2	80 x 100	2.2	30	✓
734/3	100 x 120	2.2	30	✓
734/4	120 x 150	2.2	30	✓
734/5	120 x 200	2.2	30	-
734/6	120 x 250	2.2	30	-



## COLOR

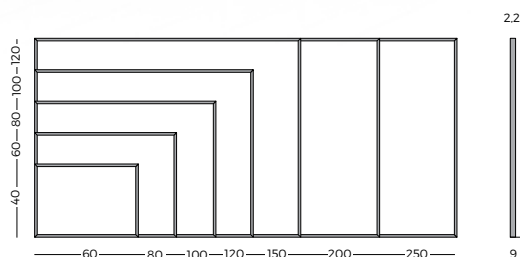

### PIZARRA DE ACERO VITRIFICADO 'MINI'

**ESP.** Pizarra mural de acero vitrificado verde. Enmarcada con perfil de aluminio anodizado Mini en color plata mate. Superficie de acero vitrificado a 800°C con garantía de por vida. Escritura con tiza. Magnética. Incluye cajetín de 30 cm.

### ENAMELLED CHALK BOARD 'MINI'

**ENG.** Enamelled chalkboard. Equipped with Mini silver anodized aluminium frame and mitred corners. Surface enamelled at 800°C. Suitable for writing with chalk. Magnetic. 30 cm en tray included. Lifetime warranty on the writing surface.

### TABLEAU ÉMAILLÉ 'MINI'

**FRA.** Tableau émaillé vert. Encadrement Mini en aluminium anodisé couleur argent. Surface émaillée vitrifiée à 800°C. Livré avec auget porte marqueurs de 30 cm. Magnétique. Superficie garantie à vie. Écriture à la craie.



### SOPORTE T

REF	↑	L	⇄	□
<b>734/T2</b>	190	100 x 80	53	30
<b>734/T3</b>	190	100 x 120	53	30
<b>734/T4</b>	190	120 x 150	53	30
<b>734/T5</b>	190	120 x 200	53	30



### SOPORTE DELTA

REF	↑	L	⇄	□
<b>734/D2</b>	190	100 x 80	53	30
<b>734/D3</b>	190	100 x 120	53	30
<b>734/D4</b>	190	120 x 150	53	30
<b>734/D5</b>	190	120 x 200	53	30



### SOPORTE Y2

REF	↑	L	⇄	□
<b>+ Y2/80</b>	190	100 x 80	53	30
<b>+ Y2/120</b>	190	100 x 120	53	30
<b>+ Y2/150</b>	190	120 x 150	53	30
<b>+ Y2/200</b>	190	120 x 200	53	30

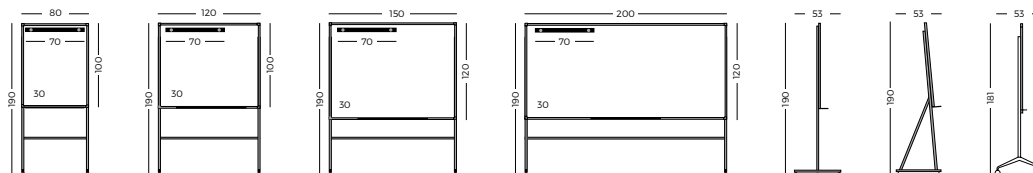

PS Capture  
App by Planning Sisplamo  
[www.planningsisplamo.com/pscapture](http://www.planningsisplamo.com/pscapture)



### ACCESORIOS

7006



7013/C



7013/B



# ZENIT

PIZARRA ZENIT DE ACERO VITRIFICADO/LAMINADA  
ENAMELLED/LAMINATED WHITEBOARD - TABLEAU ÉMAILLÉ/STRATIFIÉ



## COLOR



REF	L	H	RAIL
Z/730/A0	80 x 100	2,3	30 ✓
Z/730/A1	100 x 120	2,3	30 ✓
Z/730/A2	120 x 150	2,3	30 ✓
Z/730/A3	120 x 200	2,3	30 -
Z/730/A4	120 x 250	2,3	30 -
Z/730/A5	120 x 300	2,3	30 -



REF	L	H	RAIL
Z/730/0	80 x 120	2,3	30 ✓
Z/730/1	100 x 150	2,3	30 ✓
Z/730/2	120 x 150	2,3	30 ✓
Z/730/3	120 x 200	2,3	30 -
Z/730/4	120 x 250	2,3	30 -
Z/730/5	120 x 300	2,3	30 -

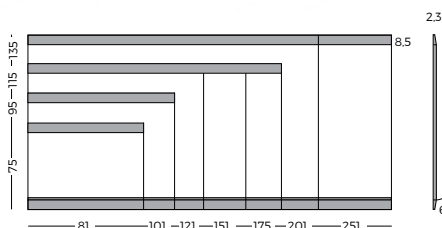

## PIZARRA ZENIT

**ESP.** Pizarra mural Zenit de acero vitrificado o laminada verde. Enmarcada con perfil de aluminio anodizado en color plata mate. Superficie de acero vitrificado a 800°C con garantía de por vida. Escritura con tiza. Incluye cajetín de 30 cm.

## ZENIT WHITEBOARD

**ENG.** Enamelled/laminated Zenit chalkboard. Equipped with silver anodized aluminium frame and plastic rounded corners. Surface enamelled at 800°C. Suitable for writing with chalk. 30 cm en tray included. Lifetime warranty on the writing surface.

## TABLEAU ZENIT

**FRA.** Tableau en acier émaillé ou stratifié vert. Encadrement en aluminium anodisé couleur argent aux coins arrondis en plastique. Surface émaillée vitrifiée à 800°C. Livré avec auget porte marqueurs de 30 cm. Surface garantie à vie. Écriture à la craie.

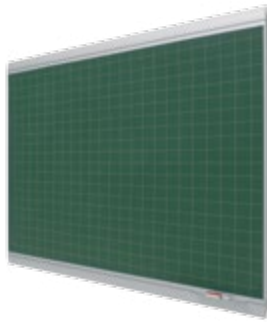

### CUADRÍCULA

REF	L	H	P
Z/730/A/C1	100 x 120	2.3	30
Z/730/A/C2	120 x 150	2.3	30
Z/730/A/C3	120 x 200	2.3	30
Z/730/A/C4	120 x 300	2.3	30

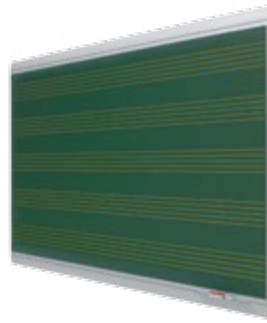

### PENTAGRAMA

REF	L	H	P
Z/730/A/P1	120 x 150	2.3	30
Z/730/A/P2	120 x 200	2.3	30
Z/730/A/P3	120 x 300	2.3	30



### SOPORTE Y2

REF	H	L	H	P
Z/730/A/Y0	190	100 x 80	53	30
Z/730/A/Y1	190	100 x 120	53	30
Z/730/A/Y2	190	100 x 150	53	30
Z/730/A/Y3	190	120 x 200	53	30

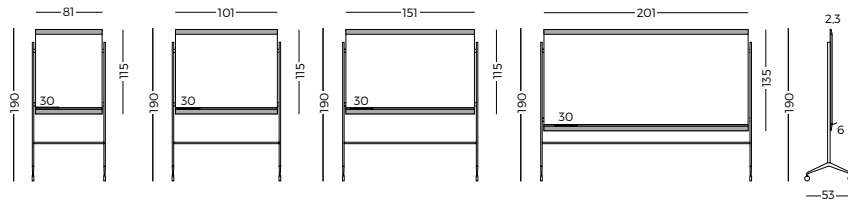

PS Capture  
App by Planning Sisplamo  
[www.planningsisplamo.com/pscapture](http://www.planningsisplamo.com/pscapture)



### ACCESORIOS

7015



7013/C



Z/7017



# 730/D - 730/T

PIZARRA DÍPTICA/TRÍPTICA  
DOUBLE/TRIPLE CHALKBOARD -  
TABLEAU DIPTYQUE/TRIPTYQUE



REF				
<b>730/D1</b>	90 x 120	90 x 60	2+2	30
<b>730/D2</b>	120 x 180	120 x 90	2+2	30

REF				
<b>730/T1</b>	90 x 240	90 x 120	2+4	30
<b>730/T2</b>	120 x 400	120 x 200	2+4	30

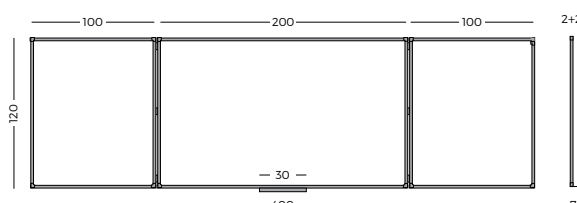
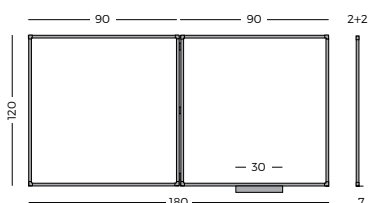

## PIZARRA DÍPTICA/TRÍPTICA

**ESP.** Pizarra díptica o tríptica de acero vitrificado verde. Enmarcada con perfil de aluminio anodizado en color plata mate y cantoneras redondeadas de plástico gris. Superficie de acero vitrificado a 800°C. Escritura con tiza. Magnética. Cajetín de 30 cm. incluido. 3 o 5 superficies de escritura.

## DOUBLE/TRIPLE CHALKBOARD

**ENG.** Double or triple enamelled chalkboard. Equipped with silver anodized aluminium frame and grey plastic rounded corners. Surface enamelled at 800°C. Suitable for writing with chalk. Magnetic. 30 cm. pen tray included. 3 or 5 writing surfaces

## TABLEAU DIPTYQUE/TRIPTYQUE

**FRA.** Tableau diptyque ou triptyque vert en acier émaillé. Cadre en aluminium anodisé couleur argent aux coins arrondis en plastique gris. Surface émaillée vitrifiée à 800°C. Effaçable à la craie. Magnétique. Livré avec un auget de 30 cm. 3 ou 5 surfaces d'écriture.



# 730/X - 730/A/X

PIZARRA VERDE VOLTEABLE  
REVOLVING CHALKBOARD - TABLEAU VERT PIVOTANT



REF	↑	L	H	□
730/A/X1	210	120 x 150	53	100
730/A/X2	210	120 x 175	53	100
730/A/X3	210	120 x 200	53	100

REF	↑	L	H	□
730/X1	210	120 x 150	53	100
730/X2	210	120 x 175	53	100
730/X3	210	120 x 200	53	100

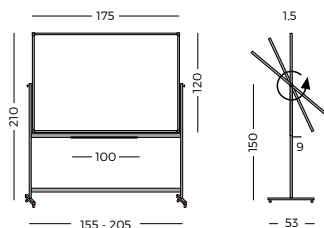

## PIZARRA VOLTEABLE

**ESP.** Pizarra volteable de doble cara laminada o de acero vitrificado verde. Enmarcada con perfil de aluminio anodizado en color plata mate y cantoneras redondeadas de plástico gris. Escritura con tiza. Estructura volteable metálica móvil provista de 4 ruedas, 2 de ellas con freno.

## REVOLVING CHALKBOARD

**ENG.** Revolving double sided enamelled or laminated chalkboard. Equipped with silver anodized aluminium frame and grey plastic rounded corners. Suitable for writing with chalk. Metallic moveable support equipped with 4 castors, 2 of them with brakes.

## TABLEAU PIVOTANT

**FRA.** Tableau double surface émaillée ou stratifiée vert rotatif. Encadrement en aluminium anodisé argent aux coins arrondis en plastique gris. Monté sur piétement. Écriture à la craie. Support métallique équipé de 4 roulettes, dont deux à freins.

# 720/VV

PIZARRA DE VAIVÉN  
VAIVÉN BOARD - TABLEAU VA-ET-VIENT

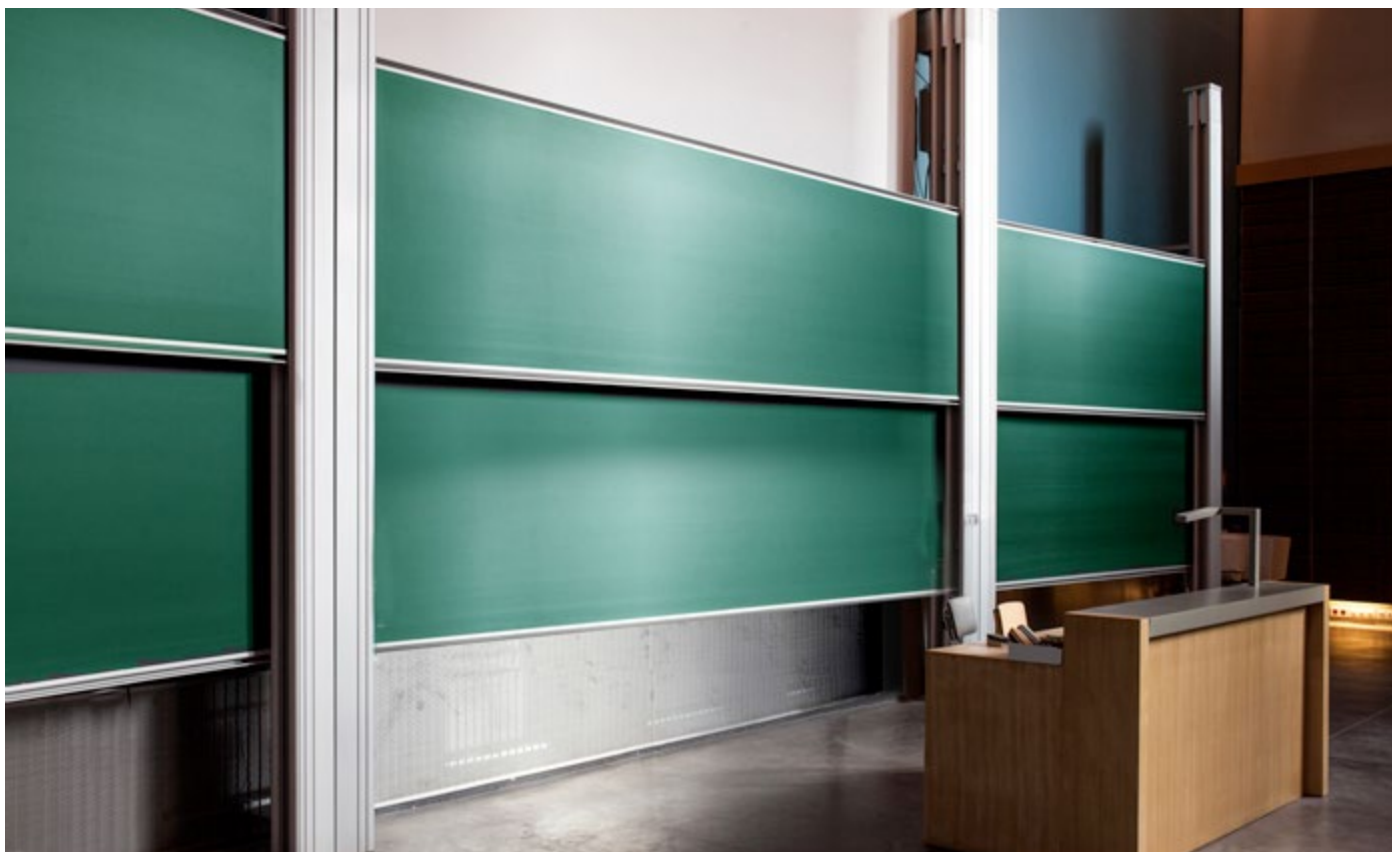

REF		L	H
730/2/VV1	x	120 x 200	12
730/2/VV2	x	120 x 250	12
730/2/VV3	x	120 x 300	12
730/2/VV4	x	120 x 400	12



## COLOR

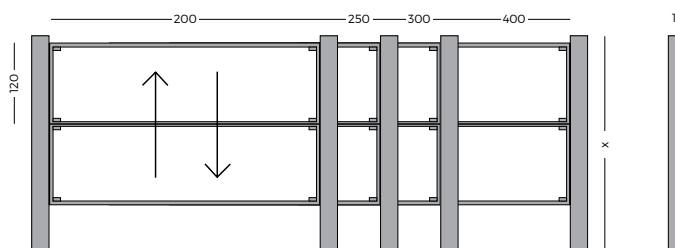

### PIZARRA VAIVÉN

**ESP.** Pizarra de acero vitrificado verde sobre una estructura de aluminio anodizado en plata mate montada sobre suelo y pared. La pizarra se desliza y va guiada en el perfil por rodamientos de nylon. Ideales para colegios, universidades, anfiteatros...

### WHITEBOARD VAIVEN

**ENG.** Enamelled chalkboard mounted upon a supporting structure in silver anodized aluminium on stand or wall fixation. The surface slide is guided through a cable transmission. The ideal communication tool for large scale presentations, lecture theatres...

### TABLEAU VA-ET-VIENT

**FRA.** Tableau vert émaillé monté sur une structure en aluminium anodisé couleur argent, fixation sol et mur. La surface se déplace sur le profil via des roulements. Pour une communication idéale dans les amphithéâtres, salles de congrès...





# 730/GG

PIZARRA DE GUILLOTINA  
GUILLOTINE BOARD - TABLEAU GUILLOTINE



**COLOR**



/VD /AZ /NG /GR

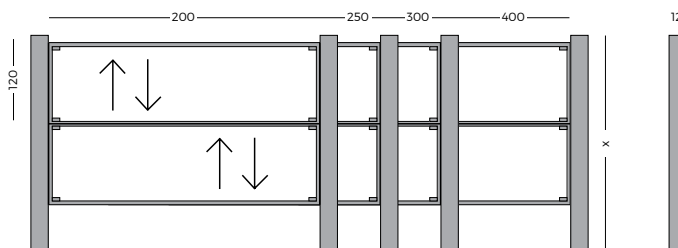

REF		L	H
730/A2/G1	x	120 x 200	12
730/A2/G2	x	120 x 250	12
730/A2/G3	x	120 x 300	12
730/A2/G4	x	120 x 400	12



**PIZARRA GUILLOTINA**

**ESP.** Conjunto de 2 pizarras verdes de acero vitrificado sobre una estructura de aluminio anodizado en plata mate montadas sobre suelo y pared. Las pizarras son independientes entre sí, guiadas por rodamiento de nylon.

**GUILLOTINE BOARD**

**ENG.** 2 enamelled chalkboards mounted upon a supporting structure in silver anodized aluminium on stand or wall fixation. Both writing surfaces slide vertically and are interdependent or each other. Guidance by nylon castors.

**TABLEAU GUILLOTINE**

**FRA.** Ensemble de 2 tableaux verts émaillés montés sur une structure en aluminium anodisé couleur argent, fixation sol et mur. Les deux surfaces se déplacent de façon indépendantes et sont guidées par des roulements.

# ACCESORIOS

ACCESORIOS  
ACCESORIES - ACCESSOIRES



**7015**

**ESP.** Borrador magnético "Design"  
**ENG.** Magnetic eraser "Design"  
**FRA.** Effaceur magnetique "Design"



**7015/1**

5 u.

**ESP.** Recambio para borrador 7015  
**ENG.** 7015 eraser felt refills  
**FRA.** Feutrines pour effaceur 7015



**7014**

**ESP.** Borrador de plástico  
**ENG.** Plastic eraser  
**FRA.** Effaceur en plastique



**7014/1**

2 u.

**ESP.** Recambio para borrador 7014  
**ENG.** 7014 eraser felt refills  
**FRA.** Feutrines pour effaceur 7014



**7006**

**ESP.** Borrador de aluminio magnético  
**ENG.** Magnetic eraser  
**FRA.** Effaceur magnetique



**7012**

**ESP.** Borrador de aluminio  
**ENG.** Eraser  
**FRA.** Effaceur



**7006/1**

20 u.

**ESP.** Recambio para borrador 7006 y 7012  
**ENG.** 7006 and 7012 eraser felt refills  
**FRA.** Feutrines pour effaceur 7006 et 7012



**7003 - 7003/30**

**ESP.** Cajetín de aluminio de 100 ó 30 cm.  
**ENG.** 100 or 30 cm. aluminium pen tray  
**FRA.** Porte-marqueurs 100 ou 30 cm.



**7013/B**

12 u.

**ESP.** Tizas blancas  
**ENG.** White chalk  
**FRA.** Craies blanches



**7013/C**

12 u.

**ESP.** Tizas de colores  
**ENG.** Colour chalks  
**FRA.** Craies de couleurs



**BL/ES/0061**

3 u.

**ESP.** Tinta líquida blanca  
**ENG.** White liquid ink  
**FRA.** Encre blanche liquide



**BL/ES/0062**

5 u.

**ESP.** Tinta líquida de colores  
**ENG.** Colour liquid ink  
**FRA.** Couleurs d'encre liquide



# PS Capture

by Planning Sislamo

Capta, clasifica y comparte el contenido de tu pizarra.  
Capture, classify and share the content of your board.  
Capturez, ordenez et partagez le contenu de votre tableau.



[planningsislamo.com/pscapture](http://planningsislamo.com/pscapture)



# **INFORMPLAN**

TABLEROS DE INFORMACIÓN  
BULLETIN BOARDS  
TABLEAUX D'INFORMATION

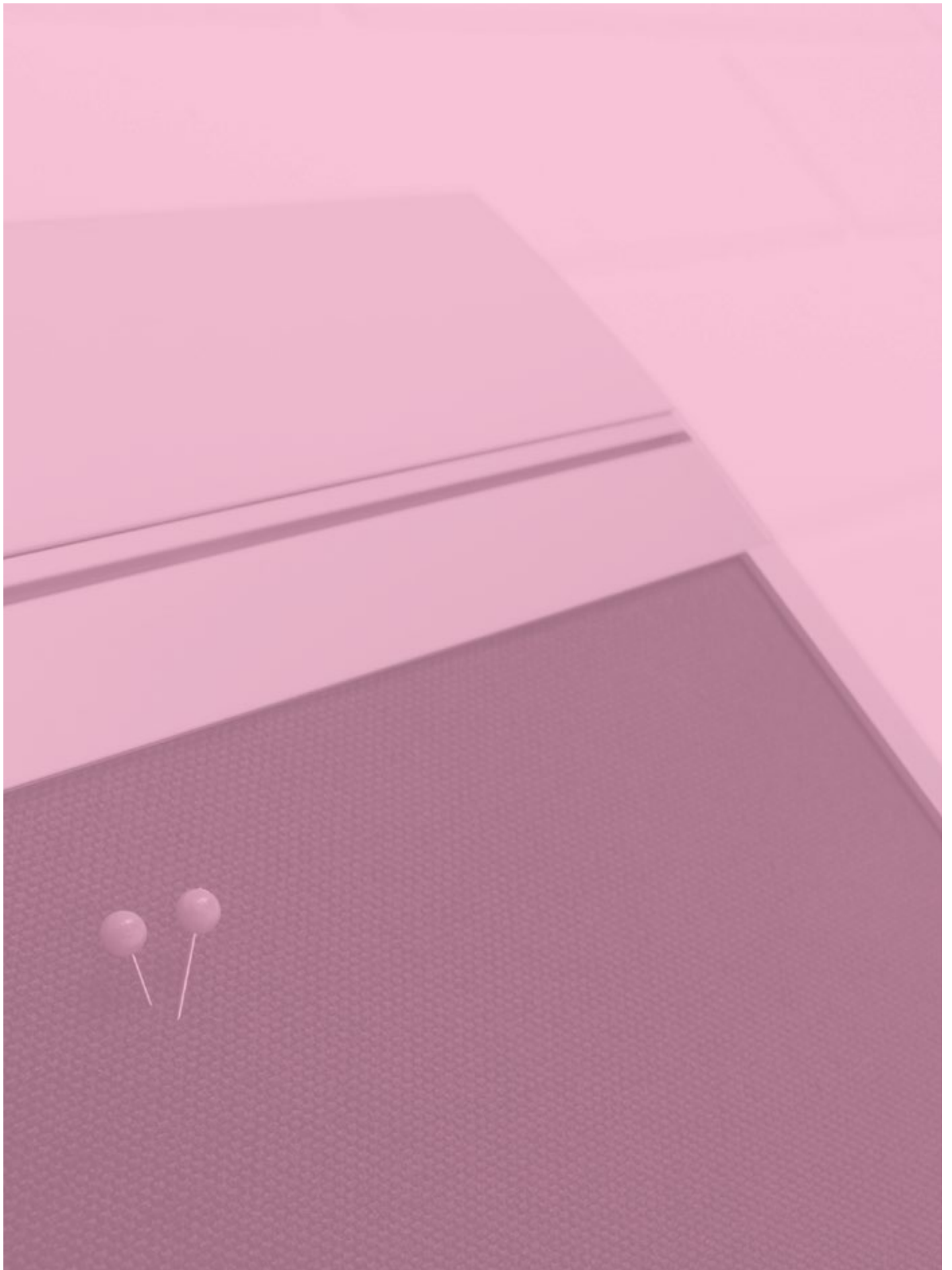

# BASIC

TABLERO DE CORCHO  
CORK BOARD - TABLEAU FOND LIÈGE



REF	L	H
BL/IN/0101	45 x 60	1
BL/IN/0102	60 x 90	1
BL/IN/0103	90 x 120	1
BL/IN/0114	100 x 150	1

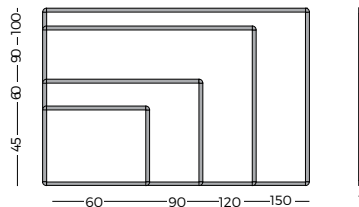

## TABLERO DE CORCHO

**ESP.** Tablero de corcho natural de 1 cm. de espesor, con marco de aluminio anodizado en plata mate y cantoneras redondeadas de plástico gris. Disponible en 4 formatos.

## CORK BOARD

**ENG.** Natural cork board (1 cm.) with anodized aluminum frame in matt silver with rounded corners made from gray plastic. Available in 4 formats.

## TABLEAU FOND LIÈGE

**FRA.** Tableau en liège naturel (1 cm.) avec cadre en aluminium anodisé couleur argent mate et coins arrondis en plastique gris. Disponible en 4 formats.



# CORK

ROLLO DE CORCHO  
ROLLER CORK - ROULEAU DE LIÈGE



## ACABADO



CORK

REF	L	H	U.
767	30 x 40	0,5	4



## COLOR



/0320 /0321 /0322 /0323 /0324 /0325 /0326

REF A	L	REF B	L	H	U.
<b>BL/IN/0320</b>	40 x 50	<b>BL/IN/0420</b>	48 x 300	0,4	1
<b>BL/IN/0321</b>	40 x 50	<b>BL/IN/0421</b>	48 x 300	0,4	1
<b>BL/IN/0322</b>	40 x 50	<b>BL/IN/0422</b>	48 x 300	0,4	1
<b>BL/IN/0323</b>	40 x 50	<b>BL/IN/0423</b>	48 x 300	0,4	1
<b>BL/IN/0324</b>	40 x 50	<b>BL/IN/0424</b>	48 x 300	0,4	1
<b>BL/IN/0325</b>	40 x 50	<b>BL/IN/0425</b>	48 x 300	0,4	1
<b>BL/IN/0326</b>	40 x 50	<b>BL/IN/0426</b>	48 x 300	0,4	1



## CORCHO ADHESIVO

**ESP.** Corcho autoadhesivo de entre 4 y 5 mm de grosor. Fácil instalación. Disponible en láminas de corcho natural y láminas o rollo de corcho pintado en 7 colores diferentes. Ideal tanto para uso doméstico como para la oficina.

## ADHESIVE CORK

**ENG.** Self-adhesive cork panels, between 4 and 5 mm thick. Easy installation. Available as a panel in colour or natural and as a roll only in colour. Ideal both for domestic use and for the office.

## LIÈGE ADHÉSIF

**FRA.** Liège auto-adhésif de 4 à 5 mm d'épaisseur. Installation facile. Disponible en feuilles de liège ou rouleau, finitions naturelles ou peints de 7 couleurs différentes. Idéal à la fois pour un usage domestique ou pour le bureau.

# 765

TABLERO DE CORCHO  
CORK BOARD - TABLEAU FOND LIÈGE



REF	L	H	RAIL
765/10	40 x 60	2.2	-
765/1	60 x 80	2.2	-
765/2	80 x 100	2.2	✓
765/3	100 x 120	2.2	✓
765/4	100 x 150	2.2	✓
765/5	100 x 175	2.2	✓
765/6	100 x 200	2.2	-
765/7	100 x 250	2.2	-

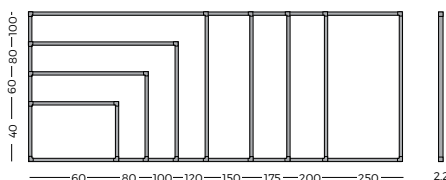

## TABLERO DE CORCHO

**ESP.** Tablero de anuncios mural con base de corcho natural, enmarcado con perfil de aluminio anodizado en color plata mate y cantoneras redondeadas de plástico gris. Se pueden fijar sobre su superficie notas, avisos, etc, mediante agujas. Corcho de 5 mm. de grosor.

## CORK BOARD

**ENG.** Cork board equipped with silver anodized aluminium frame and grey plastic rounded corners. Ideal for pinning notes, notices, posters etc. Cork thickness: 5 mm.

## TABLEAU FOND LIÈGE

**FRA.** Tableau d'affichage en liège avec encadrement en aluminium anodisé couleur argent, coins arrondis en plastique gris. Idéal pour l'affichage de notes, avis, posters, etc... par épingles et punaises. Liège de 5 mm de très bonne qualité.





### SOPORTE T

REF	↑	└	┆┆
<b>765/2/T</b>	190	100 x 80	53
<b>765/3/T</b>	190	100 x 120	53
<b>765/4/T</b>	190	120 x 150	53
<b>765/6/T</b>	190	120 x 200	53



### SOPORTE DELTA

REF	↑	└	┆┆
<b>765/2/D</b>	190	100 x 80	53
<b>765/3/D</b>	190	100 x 120	53
<b>765/4/D</b>	190	120 x 150	53
<b>765/6/D</b>	190	120 x 200	53



### SOPORTE Y2

REF	↑	└	┆┆
<b>+ Y2/120</b>	190	100 x 120	53
<b>+ Y2/150</b>	190	100 x 150	53
<b>+ Y2/200</b>	190	100 x 200	53

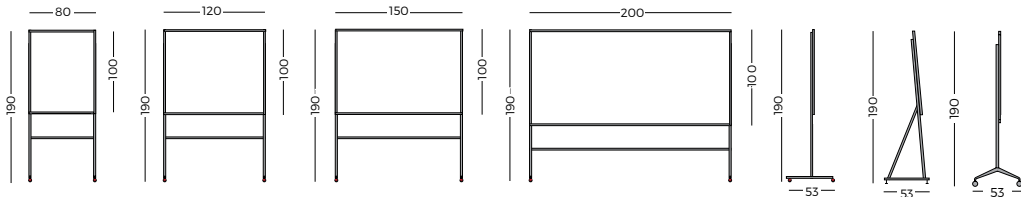

### PERSONALIZACIÓN: 765 + ...

REF	└	┆┆
<b>A4/M</b>	24,5 x 22	3,5
<b>A5/M</b>	16,5 x 16	3,5
<b>A4/3/M</b>	16,5 x 11	3,5

Disponible para Ref. 760  
 Available also for Ref. 760  
 Disponible par Ref. 760



# 760

TABLERO DE CORCHO TAPIZADO  
 FELT BOARD - TABLEAU FOND LIÈGE AVEC TISSU

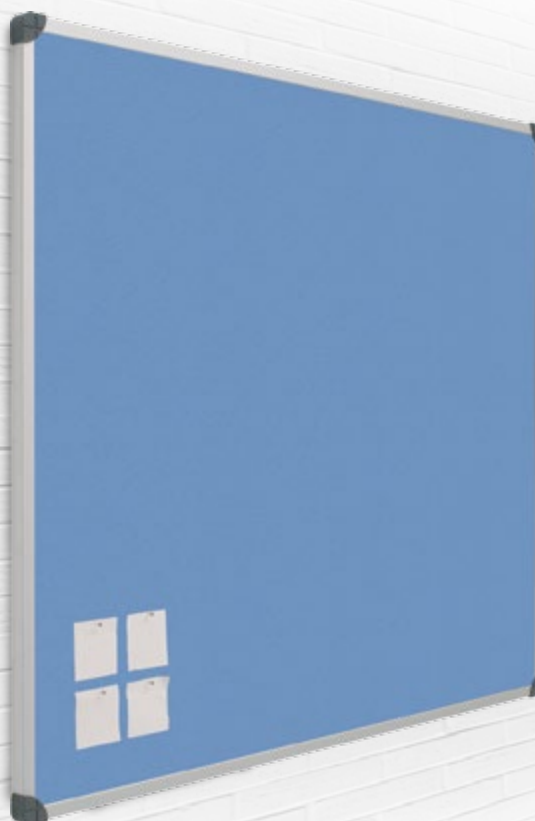
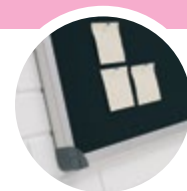

REF	L	H	RAIL
760/10	40 x 60	2.2	-
760/1	60 x 80	2.2	-
760/2	80 x 100	2.2	✓
760/3	100 x 120	2.2	✓
760/4	100 x 150	2.2	✓
760/5	100 x 175	2.2	✓
760/6	100 x 200	2.2	-
760/7	100 x 250	2.2	-

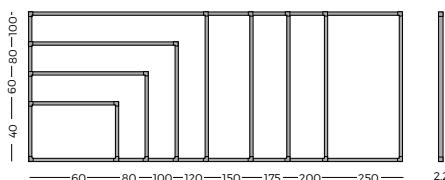

## TABLERO DE CORCHO TAPIZADO

**ESP.** Tablero de anuncios mural con base de corcho tapizado, enmarcado con perfil de aluminio anodizado en color plata mate y cantoneras redondeadas de plástico gris. Se pueden fijar sobre su superficie notas, avisos, etc, mediante agujas. Corcho de 5 mm. de grosor.

## FELT BOARD

**ENG.** Felt notice board equipped with silver anodized aluminium frame and grey plastic rounded corners. Ideal for pinning notes, notices, posters etc. Cork thickness: 5 mm.

## TABLEAU FOND LIÈGE TISSU

**FRA.** Tableau d'affichage en liège tapissé avec encadrement en aluminium anodisé couleur argent, coins arrondis en plastique gris. Idéal pour l'affichage de notes, avis, posters, etc... par épingles et punaises. Liège de 5 mm de très bonne qualité.



### SOPORTE T

REF	↑	└┘	┆┆
<b>760/2/T</b>	190	100 x 80	53
<b>760/3/T</b>	190	100 x 120	53
<b>760/4/T</b>	190	120 x 150	53
<b>760/6/T</b>	190	120 x 200	53



### SOPORTE DELTA

REF	↑	└┘	┆┆
<b>760/2/D</b>	190	100 x 80	53
<b>760/3/D</b>	190	100 x 120	53
<b>760/4/D</b>	190	120 x 150	53
<b>760/6/D</b>	190	120 x 200	53



### SOPORTE Y2

REF	↑	└┘	┆┆
<b>+ Y2/120</b>	190	100 x 120	53
<b>+ Y2/150</b>	190	100 x 150	53
<b>+ Y2/200</b>	190	100 x 200	53

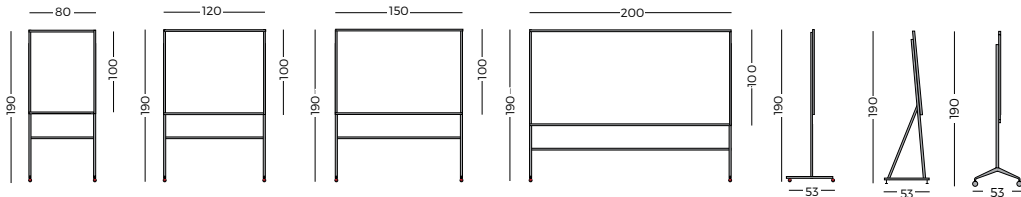

### TAPIZADO



NEGRO /NG



GRIS /GR



CREMA /CR



AMARILLO /AM



NARANJA /NJ



ROJO /RJ



BURDEOS /BD



AZUL /AZ



AZUL CLARO /AC



VERDE CLARO /VC



VERDE MEDIO /VM



VERDE /VD

# ZENIT

TABLERO ZENIT DE CORCHO  
FELT BOARD - TABLEAU FOND LIÈGE

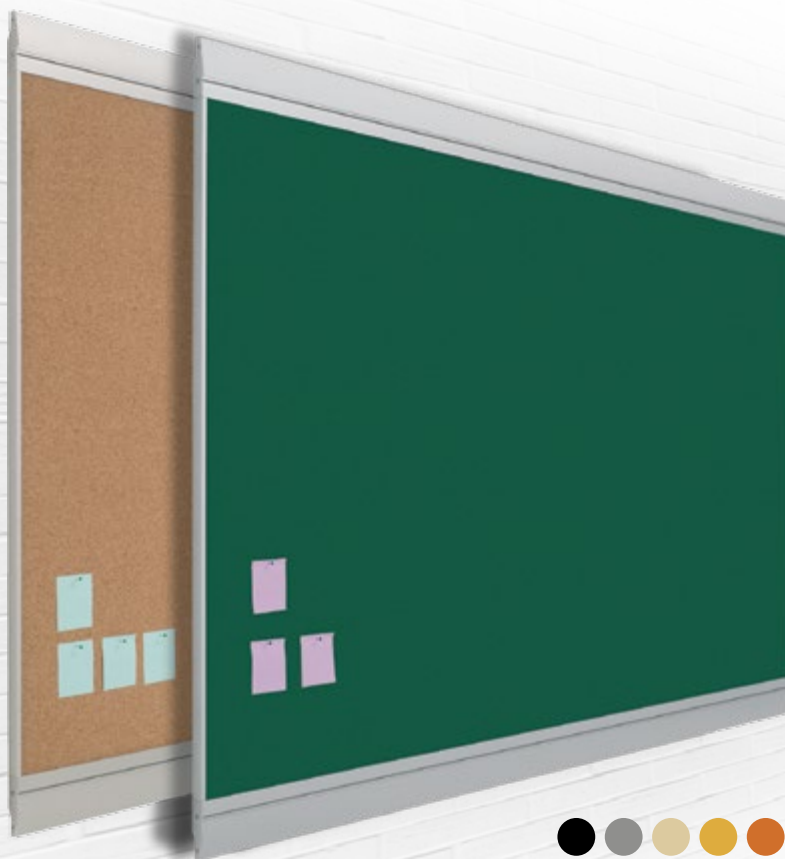

## ACABADO



CORK

## TAPIZADO



REF	L	L <sub>1</sub>	H	RAIL
Z/765/10	40 x 60	53 x 61	2,3	-
Z/765/1	60 x 80	73 x 81	2,3	-
Z/765/2	80 x 100	93 x 101	2,3	✓
Z/765/3	100 x 120	113 x 121	2,3	✓
Z/765/4	100 x 150	113 x 151	2,3	✓
Z/765/5	100 x 175	113 x 176	2,3	✓
Z/765/6	100 x 200	113 x 201	2,3	-
Z/765/7	100 x 250	113 x 251	2,3	-

REF	L	L <sub>1</sub>	H	RAIL
Z/760/10	40 x 60	53 x 61	2,3	-
Z/760/1	60 x 80	73 x 81	2,3	-
Z/760/2	80 x 100	93 x 101	2,3	✓
Z/760/3	100 x 120	113 x 121	2,3	✓
Z/760/4	100 x 150	113 x 151	2,3	✓
Z/760/5	100 x 175	113 x 176	2,3	✓
Z/760/6	100 x 200	113 x 201	2,3	-
Z/760/7	100 x 250	113 x 251	2,3	-

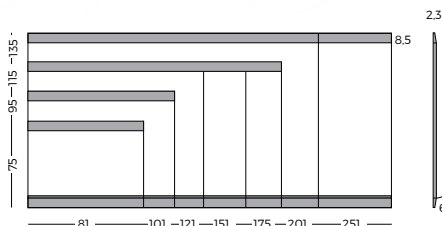

## TABLERO ZENIT DE CORCHO

**ESP.** Tablero de corcho Zénit enmarcado con perfil de aluminio anodizado en color plata (tapa personalizable). Superficie de corcho natural o tapizada en colores. Se pueden fijar sobre su superficie notas, avisos, pósters, etc, mediante agujas o chinchetas. Corcho de 5 mm. de grosor.

## ZENIT FELT BOARD

**ENG.** Cork or felt notice board, covered with colored fabric, with anodized aluminium frame (customizable). Cork 5 mm, high quality. Ideal for pinning notes, bulletins, posters, etc. Covered with fabric in colours black, bordeaux, blue, green, grey and ochre. Cork thickness: 5 mm.

## TABLEAU ZENIT FOND LIÈGE

**FRA.** Tableau d'affichage avec fond liège ou liège tapissé. Encadrement en aluminium anodisé (personnalisable). Liège de 5 mm, très bonne qualité. Idéal pour l'affichage de notes, avis, posters, à l'aide d'épingles et punaises. Liège de 5 mm de très bonne qualité.



Z/760/...

Z/765/...



### SOPORTE Y2

REF	REF	↑	└	└└	└└└
Z/765/Y2	Z/760/Y2	190	100 x 80	113 x 81	2.3
Z/765/Y3	Z/760/Y3	190	100 x 120	113 x 121	2.3
Z/765/Y4	Z/760/Y4	190	120 x 150	113 x 151	2.3
Z/765/Y6	Z/760/Y6	190	120 x 200	113 x 201	2.3

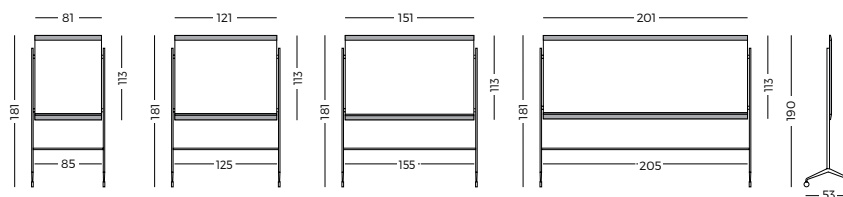

### TAPIZADO



NEGRO /NG



GRIS /GR



CREMA /CR



AMARILLO /AM



NARANJA /NJ



ROJO /RJ



BURDEOS /BD



AZUL /AZ



AZUL CLARO /AC



VERDE CLARO /VC



VERDE MEDIO /VM



VERDE /VD

# CHAMELEON FLOAT

TABLERO DE ANUNCIOS  
INFO BOARD - TABLEAU D'INFORMATION

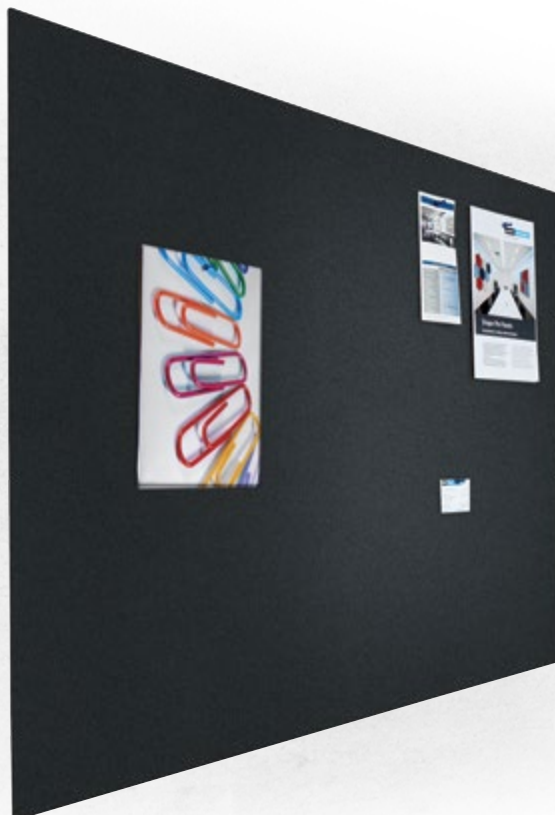

REF	L	H
7600/1	60 x 90	1,6
7600/2	90 x 120	1,6
7600/3	120 x 180	1,6
7600/4	120 x 200	1,6
7600/5	200 x 60	1,6

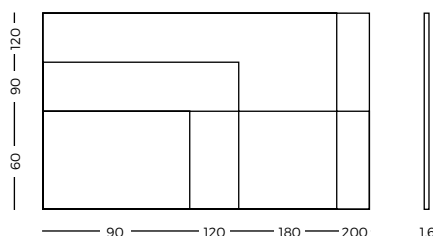

## TABLERO CHAMELEON FLOAT

**ESP.** Tablero rectangular de alta calidad de distintas medidas fabricado con materiales naturales. La superficie es auto-reparante, acústica y con una larga vida útil. Los cantos biselados dan la sensación que se encuentra flotando en la pared una vez colgado.

## CHAMELEON FLOAT PANEL

**ENG.** Rectangular panel with bevelled contour for attaching notes, warnings, etc using pins. Autoreparable surface, manufactured with natural materials and high sound-absorbing component.

## TABLEAU CHAMELEON FLOAT

**FRA.** Tableau d'affichage pour accrocher notes, avis etc à l'aide de punaises. Superficie auto-réparable fabriquée avec des matériaux naturels. Composants phono-absorbents.

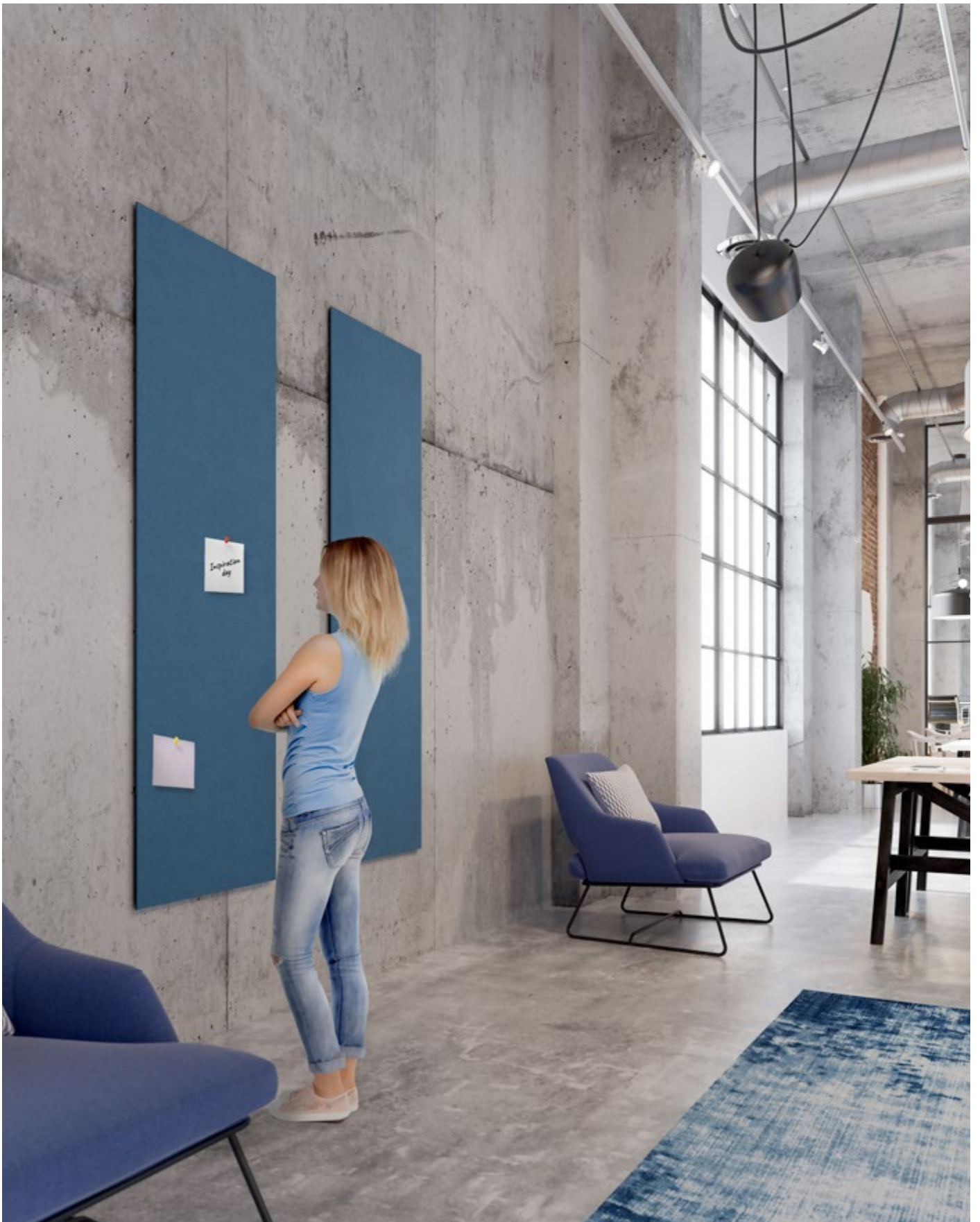

# CHAMELEON SIX-SQUARE

TABLERO DE ANUNCIOS  
INFO BOARD - TABLEAU D'INFORMATION

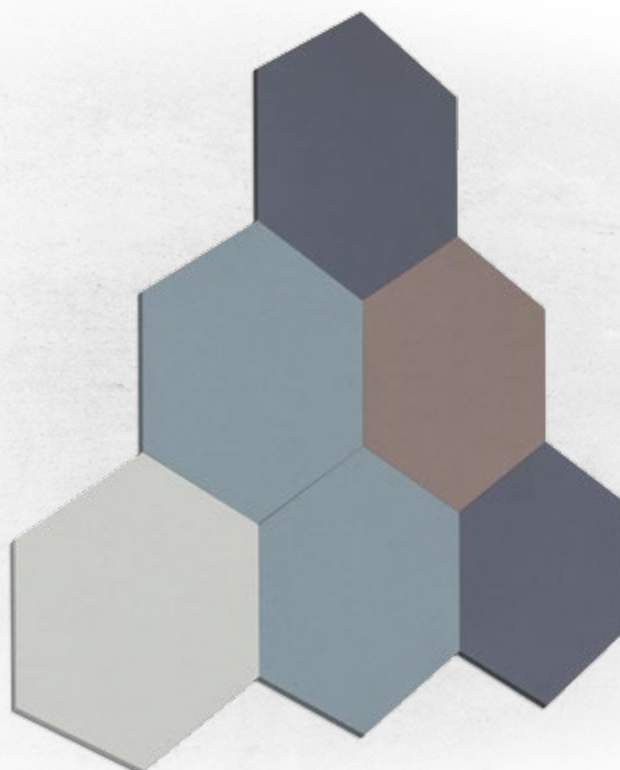

**REF**      L      H  
**7606/1**      ø60      1,6



**COLOR**



/BE /MR1 /MR2 /TC /NJ /GR /GR2 /GR3 /GR4 /GR5 /AM /VD /RJ /AZ /NG

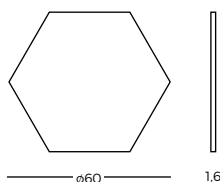

## TABLERO CHAMELEON SIX-SQUARE

**ESP.** Tablero hexagonal de alta calidad de materiales naturales. La superficie es auto-reparante, acústica y con una larga vida útil. Mezcla, diseña y crea tu configuración perfecta gracias a los 15 colores disponibles.

## CHAMELEON SIX-SQUARE PANEL

**ENG.** Hexagonal panel for attaching notes, warnings, etc using pins. Autoreparable surface, manufactured with natural materials and high sound-absorbing component. Mix, match and create the perfect constellation using the 15 different colours available.

## TABLEAU CHAMELEON SIX\_SQUARE

**FRA.** Tableau d'affichage hexagonale pour accrocher notes, avis etc à l'aide de punaises. Superficie auto-réparable fabriquée avec des matériaux naturelles. Composants phono-absorbents. Mélanger, concevoir et créer votre configuration parfait.





# CHAMELEON ROUND

TABLERO DE ANUNCIOS  
INFO BOARD - TABLEAU D'INFORMATION



## COLOR



/BE /MR1 /MR2 /TC /NJ /GR /GR2 /GR3 /GR4 /GR5 /AM /VD /RJ /AZ /NC

## REF

7608/1

L ±1-  
ø60 1.6

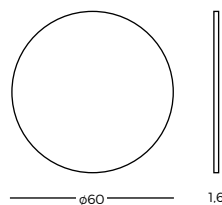

## TABLERO CHAMELEON ROUND

**ESP.** Tablero circular de alta calidad de materiales naturales. La superficie es auto-reparante, acústica y con una larga vida útil. Mezcla, diseña y crea tu configuración perfecta gracias a los 15 colores disponibles.

## CHAMELEON ROUND PANEL

**ENG.** Round panel for attaching notes, warnings, etc using pins. Autoreparable surface, manufactured with natural materials and high sound-absorbing component. Mix, match and create the perfect constellation using the 15 different colours available.

## TABLEAU CHAMELEON ROUND

**FRA.** Tableau d'affichage rond pour accrocher notes, avis etc à l'aide de punaises. Superficie auto-réparable fabriquée avec des matériaux naturels. Composants phono-absorbents. Mélanger, concevoir et créer votre configuration parfait.

# VITRINAS - /V

VITRINA DE PUERTAS CORREDERAS  
SHOWCASE SLIDING DOORS - PORTES COULISSANTES



## ACABADO - TAPIZADO



CORK /NG /GR /CR /OC /NJ /RJ /BD /AZ /AC /VC /VM /VD  
765/V 760/V

REF	REF	L	h	h
765/V1	760/V1	60 x 80	2,5	7
765/V2	760/V2	80 x 100	2,5	7
765/V3	760/V3	100 x 120	2,5	7
765/V4	760/V4	100 x 150	2,5	7
765/V5	760/V5	100 x 175	2,5	7
765/V6	760/V6	100 x 200	2,5	7

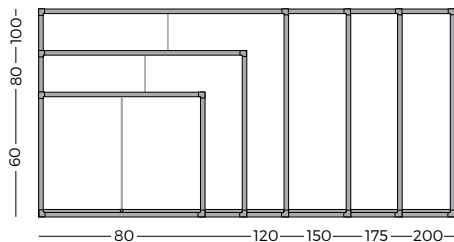

## ACABADO



PIZARRA  
720

REF	L	h	h
720/V1	60 x 80	2,5	7
720/V2	80 x 100	2,5	7
720/V3	100 x 120	2,5	7
720/V4	100 x 150	2,5	7
720/V5	100 x 175	2,5	7
720/V6	100 x 200	2,5	7



## VITRINA CON PUERTAS CORREDERAS

**ESP.** Vitrina de anuncios mural con opciones fondo de corcho, corcho tapizado o magnético, marco de aluminio anodizado en color plata mate natural y cantoneras redondeadas de zamak gris, puertas correderas de metacrilato y cerradura con llave.

## SHOWCASE WITH SLIDING DOORS

**ENG.** Showcase with cork, felt cork or magnetic surface equipped with silver anodized aluminium frame and grey zamak rounded corners, methacrylate locking sliding doors. Ideal for pinning notes, bulletins, posters, etc.

## VITRINE AVEC PORTES COULISSANTES

**FRA.** Vitrine fond en liège, liège tapissé ou magnétique avec encadrement en aluminium anodisé couleur argent, coins arrondis en zamak gris et portes coulissantes en méthacrylate avec serrure. Idéal pour l'affichage de notes, avis, posters, etc., par épingles et punaises.



### SOPORTE T - 765

REF	↑	L	□	⊥
765/V/T2	183	100 x 80	2,5	53
765/V/T3	183	100 x 120	2,5	53
765/V/T4	183	120 x 150	2,5	53



### SOPORTE T - 760

REF	↑	L	□	⊥
760/V/T2	183	100 x 80	2,5	53
760/V/T3	183	100 x 120	2,5	53
760/V/T4	183	120 x 150	2,5	53



### SOPORTE T - 720

REF	↑	L	□	⊥
720/V/T2	183	100 x 80	2,5	53
720/V/T3	183	100 x 120	2,5	53
720/V/T4	183	120 x 150	2,5	53

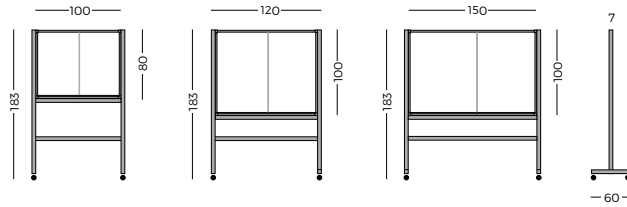

### TAPIZADO



NEGRO /NG



GRIS /GR



CREMA /CR



AMARILLO /AM



NARANJA /NJ



ROJO /RJ



BURDEOS /BD



AZUL /AZ



AZUL CLARO /AC



VERDE CLARO /VC



VERDE MEDIO /VM



VERDE /VD

# VITRINAS ZENIT

VITRINA ZENIT DE PUERTAS CORREDERAS  
SHOWCASE SLIDING DOORS - PORTES COULISSANTES



## ACABADO - TAPIZADO



CORK /NG /GR /CR /OC /NJ /RJ /BD /AZ /AC /VC /VM /VD  
765/V 760/V

REF	REF	L	L <sub>1</sub>	h	h <sub>1</sub>
Z/765/V1	Z/760/V1	55 x 75	70 x 80	2.5	7
Z/765/V2	Z/760/V2	75 x 95	90 x 98	2.5	7
Z/765/V3	Z/760/V3	95 x 115	110 x 120	2.5	7
Z/765/V4	Z/760/V4	95 x 145	110 x 150	2.5	7
Z/765/V5	Z/760/V5	95 x 170	110 x 175	2.5	7
Z/765/V6	Z/760/V6	95 x 195	110 x 200	2.5	7

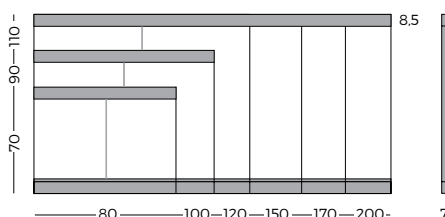

## ACABADO



PIZARRA  
720

REF	L	L <sub>1</sub>	h	h <sub>1</sub>
Z/720/V1	55 x 75	70 x 80	2.5	7
Z/720/V2	75 x 95	90 x 98	2.5	7
Z/720/V3	95 x 115	110 x 120	2.5	7
Z/720/V4	95 x 145	110 x 150	2.5	7
Z/720/V5	95 x 170	110 x 175	2.5	7
Z/720/V6	95 x 195	110 x 200	2.5	7



## VITRINA ZENIT

**ESP.** Vitrina "Zenit" de anuncios mural con opciones fondo de corcho, corcho tapizado o magnético, marco de aluminio anodizado en color plata mate natural, puertas correderas de metacrilato y cerradura con llave.

## ZENIT SHOWCASE

**ENG.** Showcase "Zenit" with cork, felt cork or magnetic surface and anodized aluminium frame. Methacrylat secured sliding doors with key. Ideal for pinning up notes, notices, posters, etc.

## VITRINE ZENIT

**FRA.** Vitrine "Zenit" fond liège naturel, liège tapissé ou magnétique avec encadrement en aluminium anodisé. Portes coulissantes en méthacrylate avec serrure. Idéal pour l'affichage de notes, avis, posters, etc., par épingles et punaises.



### SOPORTE Y2 - 765

REF	↑	L	┌	└
Z/765/NY2	181	75 x 95	90 x 100	53
Z/765/NY3	181	95 x 115	110 x 120	53
Z/765/NY4	181	95 x 145	110 x 150	53
Z/765/NY5	181	95 x 170	110 x 175	53
Z/765/NY6	181	95 x 195	110 x 200	53



### SOPORTE Y2 - 760

REF	↑	L	┌	└
Z/760/NY2	181	75 x 95	90 x 100	53
Z/760/NY3	181	95 x 115	110 x 120	53
Z/760/NY4	181	95 x 145	110 x 150	53
Z/760/NY5	181	95 x 170	110 x 175	53
Z/760/NY6	181	95 x 195	110 x 200	53



### SOPORTE Y2 - 720

REF	↑	L	┌	└
Z/720/NY2	181	75 x 95	90 x 100	53
Z/720/NY3	181	95 x 115	110 x 120	53
Z/720/NY4	181	95 x 145	110 x 150	53
Z/720/NY5	181	95 x 170	110 x 175	53
Z/720/NY6	181	95 x 195	110 x 200	53

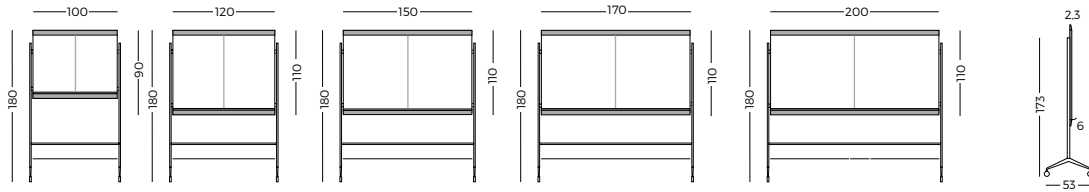

### TAPIZADO



NEGRO /NG



GRIS /GR



CREMA /CR



AMARILLO /AM



NARANJA /NJ



ROJO /RJ



BURDEOS /BD



AZUL /AZ



AZUL CLARO /AC



VERDE CLARO /VC



VERDE MEDIO /VM



VERDE /VD

# VITRINAS

VITRINA CON PUERTA ABATIBLE  
SHOWCASE WITH SWING DOOR - VITRINE PORTE BATTANTE



## ACABADO - TAPIZADO



## ACABADO



REF	REF	L	h	h	A4
765/VP/1	760/VP/1	38 x 50	1,8	3,5	4
765/VP/2	760/VP/2	70 x 50	1,8	3,5	6
765/VP/3	760/VP/3	70 x 75	1,8	3,5	9

REF	REF	L	h	h	A4
BL/IN/0110	BL/IN/0150	68,5 x 51,5	1,8	3,5	6
BL/IN/0111	BL/IN/0151	100,5 x 51,5	1,8	3,5	8
BL/IN/0112	BL/IN/0152	100,5 x 74,5	1,8	3,5	10

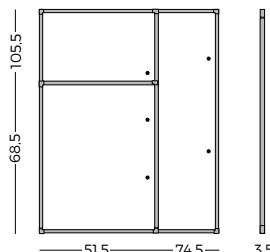
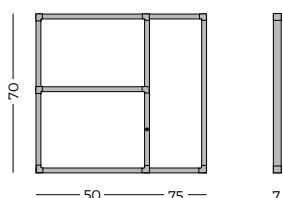

### VITRINA CON PUERTA ABATIBLE

**ESP.** Vitrina de anuncios mural con fondo tapizado o corcho natural, marco de aluminio anodizado en color plata mate natural y cantoneras redondeadas de zamak gris, puerta abatible de metacrilato y cerradura con llave. Se pueden fijar: notas, avisos...

### SHOWCASE WITH SWING DOOR

**ENG.** Showcase with cork surface equipped with silver anodized aluminium frame and grey zamak rounded corners and swing doors. Lockable. Ideal for pinning notes, bulletins, posters, etc.

### VITRINE À PORTE BATTANTE

**FRA.** Vitrine à porte battante fond liège avec encadrement en aluminium anodisé couleur argent naturel et coins arrondis en zamak gris. Équipée d'une serrure porte en méthacrylate. Idéal pour l'affichage de notes, avis, posters, etc... par épingles et punaises.



# VITRINA - /VT

VITRINA PUERTA TELESCÓPICA  
SHOWCASE HINGED DOOR - VITRINE PORTE TÉLESCOPIQUE

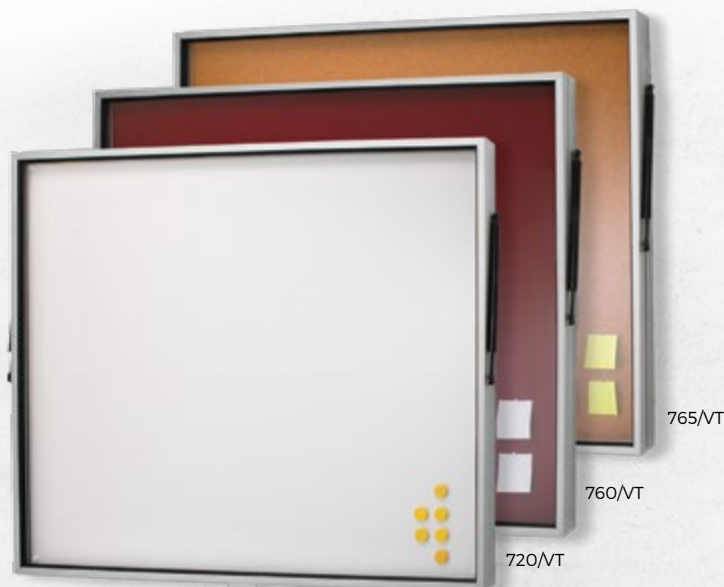

## ACABADO - TAPIZADO



CORK /NG /GR /CR /OC /NJ /RJ /BD /AZ /AC /VC /NM /VD  
765/VT 760/VT

REF	REF	L	H
765/VT1	760/VT1	60 x 80	4,5
765/VT2	760/VT2	80 x 100	4,5
765/VT3	760/VT3	100 x 120	4,5



## ACABADO



PIZARRA  
720/VT

REF	L	H
720/VT1	60 x 80	4,5
720/VT2	80 x 100	4,5
720/VT3	100 x 120	4,5

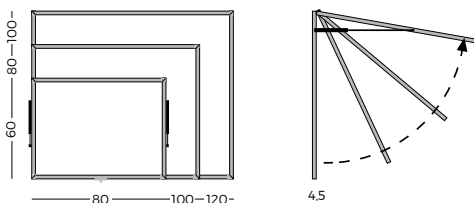

## VITRINA TELESCÓPICA

**ESP.** Vitrina de anuncios mural con fondo de corcho natural, magnético o tapizado, marco de aluminio anodizado en color plata mate natural y puerta abatible de metacrilato mediante telescópico y cerradura con llave. Se pueden fijar sobre su superficie notas, avisos, pósters, etc.

## TELESCOPIC SHOWCASE

**ENG.** Showcase with natural cork, felt cork or magnetic surface equipped with silver anodized aluminium frame and methacrylat hinged doors and lockable. Ideal for pinning notes, notices, posters, etc.

## VITRINE PORTE TÉLESCOPIQUE

**FRA.** Vitrine à l'italienne fond liège, liège tissu ou magnétique avec encadrement en aluminium anodisé couleur argent naturel. Equipé d'une serrure, porte télescopique en méthacrylate. Idéal pour l'affichage de notes, avis, posters, etc... par épingles et punaises.

# VITRINA - /VE

VITRINA EXTERIOR  
OUTDOOR SHOWCASE - VITRINE EXTÉRIEURE



REF	L	H	A4
767/VE/12	68 x 51	4,5	4
767/VE/13	68 x 72	4,5	6
767/VE/14	98 x 72	4,5	9

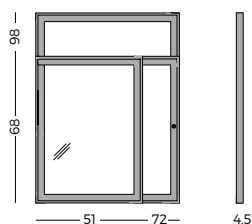

## VITRINA CON PUERTA ABATIBLE

**ESP.** Vitrinas de anuncios murales con marco de aluminio anodizado en color plata mate de puerta abatible de cristal templado y cerradura con llave. Fondo magnético blanco. Estancas a la lluvia por lo que permiten su colocación a la intemperie.

## OUTDOOR SHOWCASE

**ENG.** Showcase with cork surface equipped with silver anodized aluminium frame. Swinging door with tempered glass and locking mechanism. Magnetic white surface. Weather resistant and waterproof.

## VITRINE EXTÉRIEURE

**FRA.** Vitrine d'extérieur avec fond tableau blanc magnétique et encadrement en aluminium anodisé de couleur gris mate. Porte battante en polycarbonate et serrure clé, résistante aux intempéries.





# VITRINA - /VE

VITRINA EXTERIOR TELESCÓPICA  
TELESCOPIC OUTDOOR SHOWCASE - VITRINE EXTÉRIEURE TÉLESCOMPIQUE

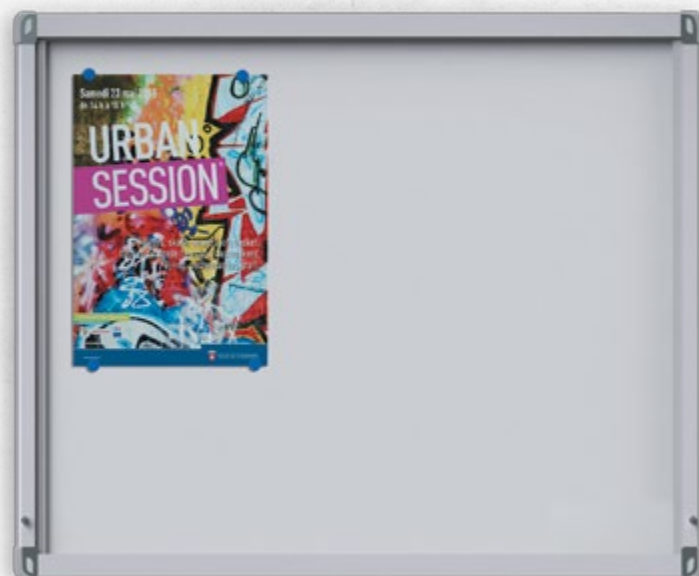

REF	L	H	A4
768/VE/11	99 x 121	5	15
768/VE/12	99 x 163	5	21
768/VE/13	101 x 204	5	27



REF	L	H	A4
768/VEP/11	98 x 117	7,5	15
768/VEP/12	98 x 160	7,5	21
768/VEP/13	98 x 202	7,5	27

+ Soporte T  
+ T support  
+ Support T

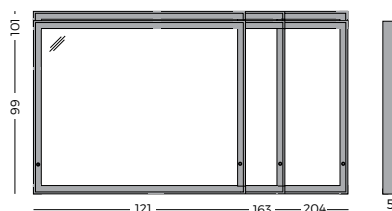

## VITRINA DE EXTERIOR

**ESP.** Vitrinas de anuncios murales o con soportes con marco de aluminio anodizado en color plata mate de puerta telescópica de cristal templado y cerradura con llave. Fondo magnético blanco. Estancas a la lluvia por lo que permiten su colocación a la intemperie.

## OUTDOOR SHOWCASE

**ENG.** Showcase with cork surface equipped with silver anodized aluminium frame. Hinged door with tempered glass and locking mechanism. Magnetic white surface. Weather resistant and waterproof.

## VITRINE EXTÉRIEURE

**FRA.** Vitrine d'extérieur avec fond tableau blanc magnétique et encadrement en aluminium anodisé argent naturel. Portes à l'italienne en polycarbonate avec serrure clé, résistante aux intempéries.

# **EXPOPLAN**

SISTEMAS DE EXPOSICIÓN  
DISPLAY SYSTEMS  
SYSTÈMES D'EXPOSITION



# NEXT BASIC

POSTES BASIC DE CORDÓN  
 QUEUE ROPE GUIDES - POTEAUX GUIDES CORDES



## POSTE DE ALUMINIO

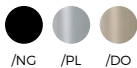

/NG /PL /DO

REF	↑	—	∅
805/NG	100	36	5
805/PL	100	36	5
805/DO	100	36	5

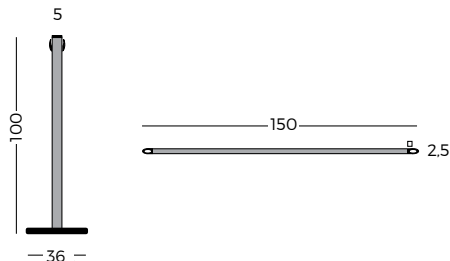

## CORDÓN



/NG /AZ /RJ /BD /CR /BL \*/NG

REF	∅	—
805/C/NG	2.5	150
805/C/AZ	2.5	150
805/C/RJ	2.5	150
805/C/BD	2.5	150
805/C/CR	2.5	150
806/C/BL*	2.5	150
806/C/NG*	2.5	150

## POSTES "BASIC" DE CORDÓN

**ESP.** Poste separador de aluminio con base metálica negra, resistente y de gran estabilidad, para separaciones de áreas y guiado peatonal. Disponible en 3 colores: negro, plata y oro. Cordón de 1,5 m, disponible en 2 trenzados distintos.

## QUEUE GUIDES "BASIC"

**ENG.** Aluminium queue guide with very stable black metallic base for separating different areas and forming organized queues. Available in 3 colours: black, silver and gold. 1.5 meter rope available in different styles (thick or thin braid).

## POTEAUX GUIDES "BASIC"

**FRA.** Poteau stable en aluminium, socle métallique noir, très résistant. S'intègre à tous les espaces d'accueil, délimitation des zones et flux piétonnier. Disponibles en 3 couleurs: noir, argent et or. Cordes de 1,5 m, disponibles en deux types de tresses.



# NEXT LUXE

POSTES LUXE DE CORDÓN  
QUEUE ROPE GUIDES - POTEAUX GUIDES CORDES



## POSTE DE ALUMINIO



/NG /PL /DO /GR /CR

REF	—	—	∅
804/CR	95	35	5
804/DO	95	35	5
804/GR	95	35	5
804/PL	95	35	5
804/NG	95	35	5

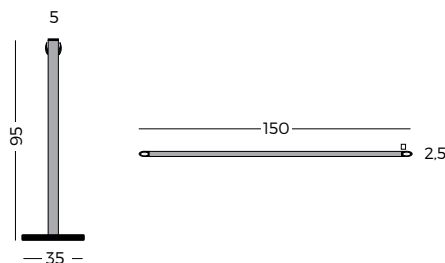

## CORDÓN



/NG /AZ /RJ /BD /CR /BL /NG

REF	∅	—
804/C/NG	2.5	150
804/C/AZ	2.5	150
804/C/RJ	2.5	150
804/C/BD	2.5	150
804/C/CR	2.5	150
804/CT/BL	2.5	150
804/CT/NG	2.5	150

## POSTES "LUXE" DE CORDÓN

**ESP.** Poste separador de tubo y base de latón, resistente y de gran estabilidad, para separaciones de áreas y guiado peatonal. Disponible en 5 colores. Cordón de 1,5 m, disponible en 2 trenzados distintos.

## QUEUE GUIDES "LUXE"

**ENG.** Queue guide with a very stable brass base for separating different areas and forming organized queues. Available in 5 colours. 1,5 meter rope available in different styles (thick or thin braid).

## POTEAUX GUIDES "LUXE"

**FRA.** Poteau avec socle en laiton, très stable et résistant. S'intègre à tous les espaces d'accueil, délimitation des zones et flux des piétons. Disponibles en 5 couleurs. Cordes de 1,5 m, disponibles en deux types de tresses différentes.

# NEXT TRAC

POSTES DE CINTA RETRÁCTIL  
RETRACTABLE QUEUE GUIDES - POTEAU À SANGLE RÉTRACTABLE



## POSTE METÁLICO



## POSTE LACADO



## CORDÓN



REF	↑	→	∅
808/...	95	35	7



REF	DESCR.	↑	→	∅
808/F/LC	Poste Final	95	35	7
808/F/M	Poste Final	95	35	7
800/TP	Mural	7	1	-

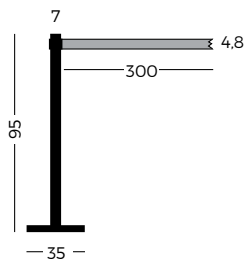

## POSTES DE CINTA RETRÁCTIL

**ESP.** Poste separador metálico de 95 y 50 cm de alto, para separaciones de áreas y guiado peatonal. Disponibles en varios colores tanto de poste como de cinta, disponible en 3 m. de largo. El cabezal del poste incorpora 3 vías de enganche.

## RETRACTABLE QUEUE GUIDES

**ENG.** 50 or 95 cm height barrier-post for areas delimitation and users guidance. Posts and tapes available in different colors. 3 m. tapes. 1 tape starting slot and 3 ending slots for multiple layouts.

## GUIDE-FILES À SANGLE RÉTRACTABLE

**FRA.** Poteau guide-file de 50 ou 95 cm. de haut pour délimitation d'espaces et guidage des usagers. Poteaux et sangles disponibles dans différentes couleurs. Sangles de 3 m. Un départ de sangle et 3 arrivées permettant de nombreuses configurations.



**SOPORTE DIN A4**

**REF**      L      ?  
**800/PP**      30 x 21      A4

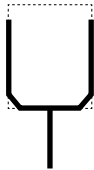

**PERSONALIZADO**

**ESP.** Consigue una cinta retráctil personalizada con el logotipo de tu empresa o marca. Contáctate con nuestra Oficina Técnica para más detalles.

**ENG.** Customize your queue guides with a company or brand logo. For more information, contact our Technical Departments.

**FRA.** Obtenir votre sangle retractable personnalisée avec le logo ou la marque de votre entreprise. Contactez nous pour plus de détail.

**GAMA DE COLORES**



REF.	/BL	/NG	/GR	/AZO	/AZ	/BD	/RJ	/NJ	/AM	/FL	/VD
	Blanco	Negro	Gris	Azul oscuro	Azul	Burdeos	Rojo	Naranja	Amarillo	Fluorescente	Verde
	White	Black	Grey	Dark Blue	Blue	Cardinal	Red	Orange	Yellow	Fluorescent	Green
	Blanche	Noir	Gris	Bleu foncé	Bleu	Bordeaux	Rouge	Orange	Jaune	Fluorescent	Vert

# NEXT ECO

POSTE ECO DE CINTA RETRÁCTIL  
BARRIER-POST "ECO" RETRACTABLE - POTEAU À SANGLE RÉTRACTABLE



REF	↑	←	∅
803/E2/NG	95	35	5
803/E2/RJ	95	35	5



## COLOR

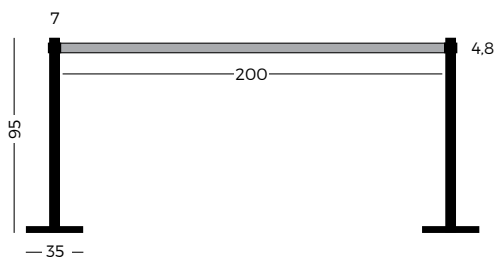

### POSTES METÁLICOS "ECO"

**ESP.** Caja de 2 postes separadores metálicos de 95 cm de alto, para separaciones de áreas y guiado peatonal. Poste de color negro y cinta retráctil de 2 m. disponible en rojo y negro.

### BARRIER-POSTS "ECO"

**ENG.** Barrier-post eco 95 cm for areas delimitation and users guidance. Black posts, tape available in red or black. One starting slot and 3 ending slots for multiple layouts.

### POTEAUX GUIDE-FILE "ÉCO"

**FRA.** Poteau guide-file éco 95 cm. de haut pour délimitation d'espaces et guidage des usagers. Poteaux noirs, sangle rouge ou noire. Un départ de sangle et 3 arrivées permettant différentes configurations.





# NEXT WALL

CINTA EXTENSIBLE RETRÁCTIL MURAL  
WEBBING FELT FOR WALL - SANGLE RETRACTABLE MURALE

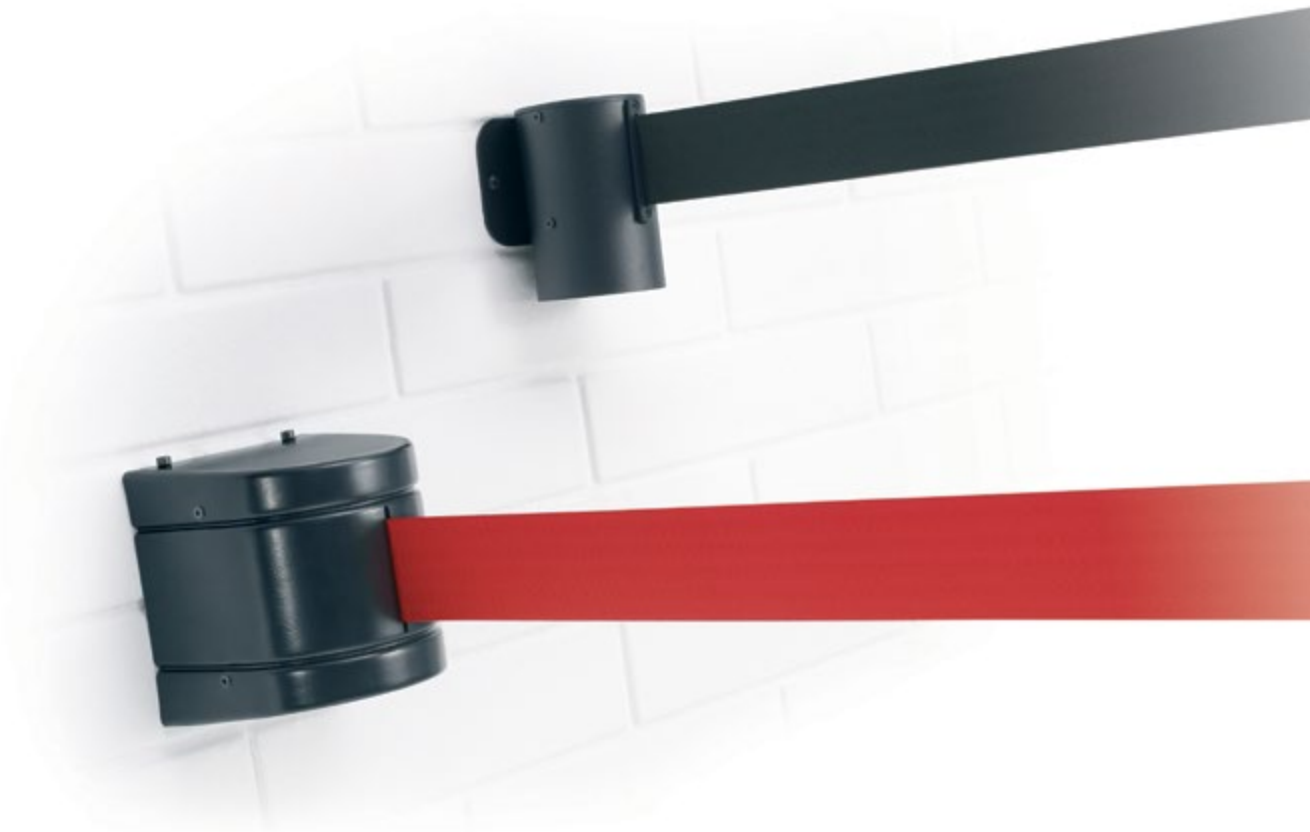

REF	↑	→
800/23	4,8	250
800/37	4,8	370
800/52	4,8	520
800/77	4,8	770

REF	DESCR.	↑	→	∅
800/TP	Mural	7	1	-

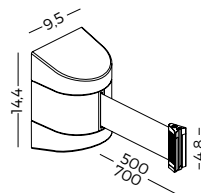
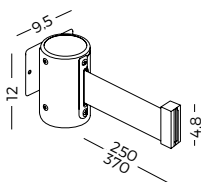

## CINTA EXTENSIBLE RETRACTIL MURAL

**ESP.** Elemento mural de cinta extensible retráctil, permite de manera rápida y segura aislar provisionalmente áreas o zonas de paso, y cerrar puertas o zonas determinadas. Disponible en 4 longitudes; 2,5 m., 3,7 m., 5,2 m. y 7,7 m.

## WEBBING FELT FOR WALL

**ENG.** Wall adjustable barrier belt for quick and easy use to close off areas temporarily. Available in 4 lengths; 2,5 m., 3,7 m., 5,2 m. y 7,7 metres.

## SANGLE RETRACTABLE MURALE

**FRA.** Sangle murale rétractable avec système d'autofreinage afin qu'elle ne se rétracte pas brusquement en cas de décrochage. Délimitation efficace et rapide de tout type de surfaces. Disponible en quatre longueurs: 2,5 m., 3,7 m., 5,2 m. et 7,7 mètres.

# 821-823

ATRIL DE MARCO ABATIBLE  
SNAPFRAME LECTERN - PUPITRE À CADRE CLIPPANT



REF	↑	→	☐
<b>821/A3</b>	110	30 x 40	A3
<b>821/A4</b>	110	30 x 40	A4

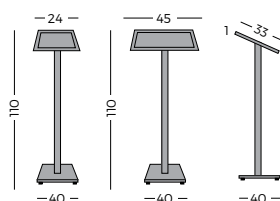

REF	↑	→	☐	CA
<b>823/PF/CA</b>	127,6	25 x 33	A4	Si

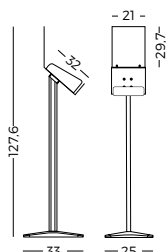

REF	↑	→	☐	CA
<b>823/PF</b>	116,3	25 x 33	A4	No

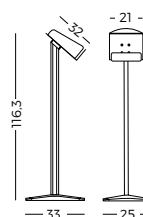

## ATRIL DE MARCO ABATIBLE

**ESP.** Atril expositor de aluminio de marco abatible para exponer toda clase de información, catálogos, menús... El portapóster superior A4 y A3 permite adaptarse al soporte en posición vertical u horizontal.

## SNAPFRAME LECTERN

**ENG.** Snapframe aluminium display, ideal to show all sorts of information, catalogues, menus, etc... The upper snapframe A4 and A3 allows to place it vertical or horizontal.

## PUPITRE À CADRE CLIPPANT

**FRA.** Pupitre en aluminium à cadre clippant pour exposer tout type d'informations, catalogues, menus, etc... Le porte affiche A4 ou A3 peut se positionner horizontalement ou verticalement.



# 822

ATRIL DE MARCO ABATIBLE Y REGULABLE  
ADJUSTABLE LECTERN WITH SNAPFRAME - MENUBOARD FLEXIBLE



REF	W x H	Inclination	Format
<b>822/A3</b>	42 x 30	0 - 90°	A3
<b>822/A4</b>	33 x 24	0 - 90°	A4

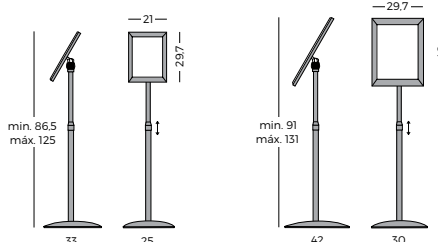
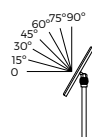

REF	W x H	Inclination	Format	Power
<b>822/A3/L</b>	42 x 30	0 - 90°	A3	2000-2200 W
<b>822/A4/L</b>	33 x 24	0 - 90°	A4	2000-2200 W



### ATRIL MARCO ABATIBLE Y REGULABLE

**ESP.** Atril expositor graduable en altura de aluminio de marco abatible para exponer toda clase de información, catálogos, menús. El portapóster superior Din A4 y Din A3 permite adaptarse al soporte en posición vertical y horizontal y es graduable en inclinación de 0° a 90°. (Disponible con caja de luz LED)

### ADJUSTABLE LECTERN SNAP FRAME

**ENG.** Height adjustable lectern made of aluminium and with snap frame to hold menus, catalogues, general information...The snap frame is available in A4 and A3 format and can be positioned horizontal or vertically and with a inclination from 0° to 90°. (Led showcase light available)

### MENUBOARD FLEXIBLE

**FRA.** Pupitre exposant réglable en hauteur et en aluminium avec cadre auto clippant pour exposer toutes sortes d'informations, catalogues, menus. La partie supérieure pour documents format A4 et A3 et avec l'inclinaison verticale et horizontale réglable de 0° à 90°. (Disponible Pupitre exposant avec LED)

# 832-2400

EXPOSITORES DE INFORMACIÓN  
INFO DISPLAYS - PORTE-AFFICHES



**REF** | — — □  
**832/4** 186 72 x 40 4



**REF** | — — □  
**2400/1B** 186 72 x 40 1

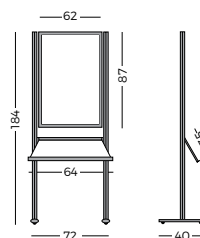
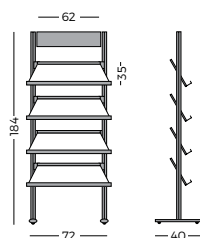

## EXPOSITORES DE INFORMACIÓN

**ESP.** Expositores compuestos por 2 perfiles elípticos verticales de aluminio en plata mate, con estantes metálicos pintados en color gris. Ideal para catálogos y revistas en formato DIN A4.

## INFO DISPLAYS

**ENG.** Displays made of 2 vertical elliptical aluminum supports in matt silver. Metallic shelves painted in grey. Ideal for catalogues and magazines in A4 format. At the top there is a grey panel, which can be personalized.

## PORTE-AFFICHES

**FRA.** Présentoirs composés de 2 supports élliptiques verticaux en aluminium couleur argent mat avec des étagères métalliques grises. Idéal pour catalogues et revues format A4.



# QUADRA

EXPOSITORES DE INFORMACIÓN  
MAGAZINES DISPLAYS - PRÉSENTOIRS



REF	↑	→	□
<b>Q/400/PE</b>	195	100 x 40	1
<b>Q/400/PE/D</b>	195	100 x 40	2

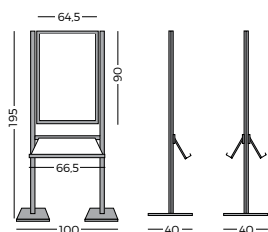

REF	↑	→	□
<b>Q/400/3</b>	195	100 x 40	3
<b>Q/400/3/D</b>	195	100 x 40	6

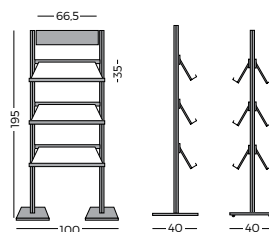

## EXPOSITORES DE INFORMACIÓN

**ESP.** Conjunto formado por un portapósters de formato DIN A1, a una o dos caras y portaestantes metálico gris sobre estructura doble de aluminio anodizado en plata mate, serie Quadra.

## MAGAZINES DISPLAYS "QUADRA"

**ENG.** Displays made of 2 vertical elliptical aluminum supports in matt silver. Metallic shelves painted in grey. Ideal for catalogues and magazines in A4 format. The shelves can be placed on one or both sides.

## PRÉSENTOIRS "QUADRA"

**FRA.** Présentoirs composés de 2 supports "Quadra" verticaux en aluminium couleur argent mat avec des étagères métalliques grises. Idéal pour catalogues et revues format A4. Les étagères peuvent se situer sur un ou deux côtés.

# Q-T

POSTE DE INFORMACIÓN  
INFO SYSTEM - BARRE D'INFORMATION



REF	↑	—
<b>Q/198</b>	95	30 x 40
<b>Q/199</b>	150	30 x 40
<b>Q/200</b>	195	30 x 40
<b>Q/201</b>	225	30 x 40

No incluye accesorios.  
Does not include accessories.  
Accessoires non inclus.

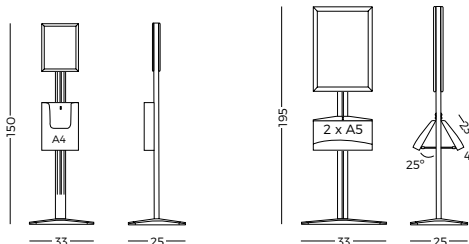

REF	↑	—
<b>T/198</b>	95	30 x 40
<b>T/199</b>	150	30 x 40
<b>T/200</b>	195	30 x 40
<b>T/201</b>	225	30 x 40

No incluye accesorios.  
Does not include accessories.  
Accessoires non inclus.



## POSTE DE INFORMACIÓN "QUADRA"

**ESP.** Sistema de exposición compuesto de un perfil de aluminio anodizado plata mate vertical, con base metálica cuadrada pintada en color gris. El perfil tiene dos ranuras sobre las que podemos aplicar diferentes accesorios, pinzas, portafolletos, etc.

## INFO SYSTEM "QUADRA"

**ENG.** Display system composed of a vertical matt silver aluminum anodized profile with a metallic square base painted in grey. The profile has 2 slots to be fitted with accessories like grips, document holders, etc. Ideal for congresses, exhibitions, sale points, etc..

## BARRE D'INFORMATION "QUADRA"

**FRA.** Système d'exposition composé d'une barre verticale en aluminium anodisé de couleur argent avec un socle carré en métal de couleur gris. La barre est rainurée sur ses 2 cotés opposés pour y fixer différents accessoires, pinces, portes brochures ou dépliant.



### MARCO

REF	┌	┐	└┘
<b>850/I/M0</b>	82 x 117	A0	1,2
<b>850/I/M1</b>	57 x 82	A1	1,2
<b>850/I/M2</b>	40 x 58	A2	1,2
<b>850/I/M3</b>	68 x 98	70 x 100	1,2
<b>850/I/M4</b>	48 x 68	50 x 70	1,2
<b>850/I/M5</b>	42 x 29,7	A3	1,2
<b>850/I/M6</b>	21 x 29,7	A4	1,2



### DISPLAY

REF	┌	┐	└┘
<b>A4/M</b>	24,5 x 22	A4	3,5
<b>A5/M</b>	16,5 x 16	A5	3,5
<b>A4/3/M</b>	16,5 x 11	1/3 A4	3,5



### BANDEJA

REF	┌	┐
<b>Q/2205</b>	22 x 35	A4

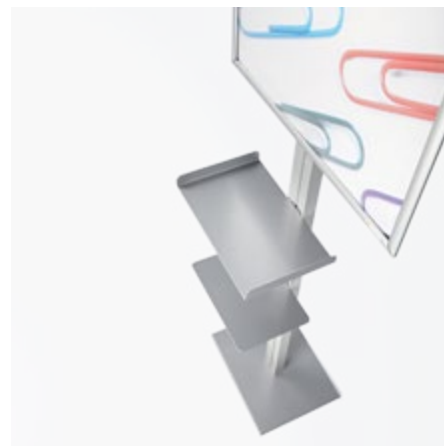

# 850

PORTAPÓSTERS CON MARCO ABATIBLE  
WALL SNAPFRAME - CADRE MURAL CLIPPANT



REF	┌	┐	┆┆
<b>850/I/M0</b>	87 x 122	A0	1,2
<b>850/I/M1</b>	62 x 87	A1	1,2
<b>850/I/M2</b>	43 x 62	A2	1,2
<b>850/I/M3</b>	73 x 103	70 x 100	1,2
<b>850/I/M4</b>	53 x 73	50 x 70	1,2
<b>850/I/M5</b>	33 x 43	A3	1,2
<b>850/I/M6</b>	24 x 33	A4	1,2



## COLOR



\* /NG /BL /AM /RJ /AZ /VD /NJ

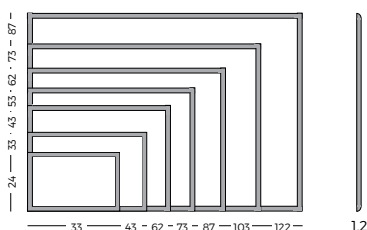

### PORTAPÓSTERS MURAL

**ESP.** Sistema de presentación de pósters, con marco abatible de aluminio anodizado en plata mate a inglete, que permite la sustitución del impreso de una manera rápida y cómoda.

### WALL SNAPFRAME

**ENG.** Modern and practical snapframe with durable aluminium clip frames and mitred corners. Folding for posters presentation. Poster or sheets are protected by a thin laminated plastic AV proof non reflects.

### CADRE MURAL CLIPPANT

**FRA.** Porte-affiche en aluminium anodisé couleur argent angles droits. Ces cadres garantissent une excellente tenue des documents. L'affiche des documents sont protégées par une feuille en plastique transparente anti reflets - anti UV.





### DELTA

REF	┌	?	↑
<b>850/I/D1</b>	62 x 87	A1	127
<b>850/I/D3</b>	73 x 103	70 x 100	107
<b>850/I/D4</b>	53 x 73	50 x 70	93



### SUSPENDIDO

REF	┌	?	↑
<b>850/I/S0</b>	87 x 122	A0	2.4
<b>850/I/S1</b>	62 x 87	A1	2.4
<b>850/I/S2</b>	43 x 62	A2	2.4
<b>850/I/S3</b>	73 x 103	70 x 100	2.4
<b>850/I/S4</b>	53 x 73	50 x 70	2.4

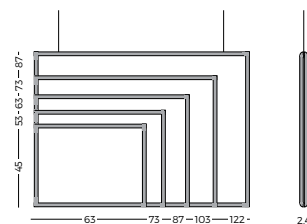
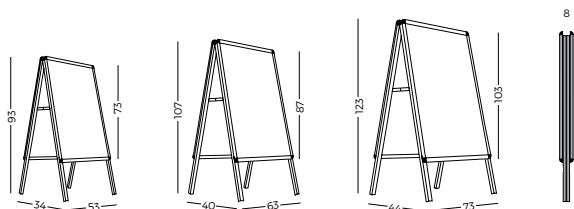

### PERSONALIZACIÓN

**ESP.** Personalización bajo pedido. Valoración según cantidad.



**ENG.** Customization under order. Ask for quantities.

**FRA.** Personnalisation sous commande. Demander quantité

# EXPOSITOR



EXPOSITORES PARA CATÁLOGOS O TARJETAS  
 INFORMATION OR CARD RACKS - PRÉSENTOIRS

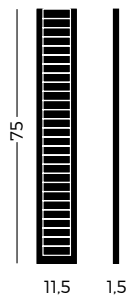
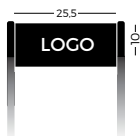
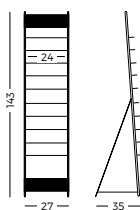

**REF**   

**835/C/10** 143 27 x 35 10 x A4



**REF**   

**319** 75 11,5 25

## EXPOSITORES PARA CATÁLOGOS

**ESP.** Expositor para catálogos y/o revistas verticales construidos con varilla negra y cromada o para tarjetas. Su estructura es desmontable y está disponible para catálogos formato A4 o 25 tarjetas.

## INFORMATION RACKS

**ENG.** Information racks for catalogues and/or magazines or for cards, manufactured with black chrome stems. Dismantle the structure easily for temporary use. Available for catalogues in A4 format (10 trays) or 25 cards.

## PRÉSENTOIRS

**FRA.** Présentoir à catalogues et/ou revues verticales et cards, fabriqués en métal noir et chromée. Structure démontable pour formats A4 ou 25 cards.



# 837

EXPOSITOR INCLINADO  
INCLINED DISPLAY - PRÉSENTOIR INCLINÉ



REF	—	—	?
<b>837/24</b>	150	24	4 x A4
<b>837/45</b>	150	45	8 x A4

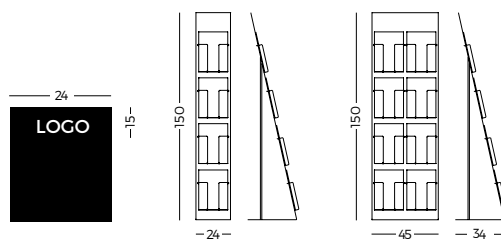

REF	—	—	?
<b>VS/A4</b>	30 x 21	3	A4
<b>VS/A5</b>	21 x 15	3	A5
<b>VS/A4/3</b>	15 x 10	3	1/3 A4

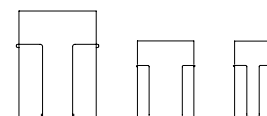

## EXPOSITOR DE CHAPA

**ESP.** Expositor de chapa con cajetines de varilla metálica formando la composición deseada en cada momento. Las cajetines están disponibles en Din A4, A5 y formato tríptico. La parte superior puede ser rotulada o vinilada bajo pedido.

## INCLINED DISPLAY IN METAL

**ENG.** Inclined display "Alians" made of perforated metallic structure and surface with metallic wire trays. Trays sizes can be A4, A5 or 1/3 of A4. Upper side can be personalized (logo or text).

## PRÉSENTOIR INCLINÉ EN MÉTAL

**FRA.** Présentoir incliné "Alians" en métal. Présentoir incliné en métal perforé avec porte-brochures en tiges métalliques. Composition modulable sur formats A4 et A5 et tryptique. La partie supérieure peut être personnalisée (logo ou texte).

# NOTE

PERFIL PORTANOTAS  
NOTES HOLDER PROFILE - PROFIL DE SUPPORT DE NOTES



REF	PÓSTER	(X)	-  -
<b>BL/EX/0040</b>	31	33,5	5
<b>BL/EX/0041</b>	50	52,5	5
<b>BL/EX/0042</b>	58	60,5	5
<b>BL/EX/0043</b>	88	90,5	5
<b>BL/EX/0044</b>	100	102,5	5
<b>BL/EX/0045</b>	118	120,5	5
<b>BL/EX/0046</b>	150	152,5	5

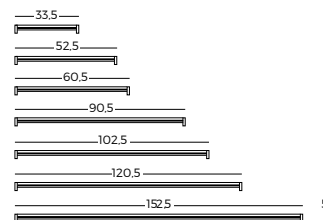
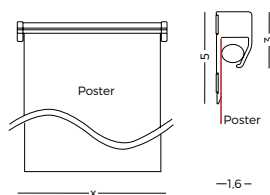

## PERFIL PORTANOTAS

**ESP.** Perfil de aluminio anodizado en color plata mate que se fija a la pared mediante tornillos ocultos en la tapa lateral, para fijar notas, pósters, dibujos, planos, etc.

## NOTES HOLDER PROFILE

**ENG.** Silver anodized aluminium profile fixed to the wall through hidden screws on the lateral cover. Ideal for hanging up notes, posters, drawings, plans, etc...

## PROFIL DE SUPPORT DE NOTES

**FRA.** Profil en aluminium anodisé mat, fixé au mur par des vis ou par une bande magnétique (au choix). Idéal pour fixer des notes, posters, dessins, plans, etc...



# 840

EXPOSITOR INCLINADO  
WALL AND FLOOR ANNOUNCEMENT BOARDS - PORTE BROCHURES



**TAPIZADO**



REF	W	H	D	C
840/G	115 x 80	3	9 x A4	
840/P	90 x 58	3	12 x 1/3 A4	

REF	REF	REF	W	H	D	C
840/TG	840/DG	840/QG	190	115 x 80	3	9 x A4
840/TP	840/DP	840/QP	190	90 x 58	3	12 x 1/3 A4

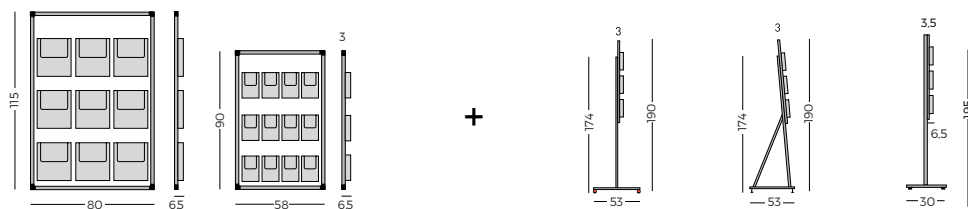

**PORTAFOLLETOS MURALES Y CON PIÉ**

**ESP.** Portafolletos de metacrilato DIN A4 y 1/3 DIN A4 montados sobre tableros tapizados en téxtil y enmarcados con perfil de aluminio. Bajo presupuesto pueden fabricarse combinaciones con formatos de cajetines (Din A4, A5 y tríptico).

**WALL AND FLOOR BOARDS**

**ENG.** Methacrylate trays DIN A4 and 1/3 A4 mounted on aluminium anodized silver frame felt announcement boards. Special order boards with different trays in different formats (A4 and A5 and brochures) can be manufactured.

**PORTE BROCHURES**

**FRA.** Porte brochures en méthacrylate format A4 et 1/3 A4 montés sur des panneaux tapissés. Sur commande on peut fabriquer des combinaisons différents formats de cases (A4, A5 et triptyques).

# 2000 - TEN

SISTEMA DE CABLES Y TENSORES  
CABLE AND TENSION SYSTEM - SYSTÈME DE CABLE ET POCLETTE



## CARPETAS

REF ?

<b>ST/A4/V</b>	A4	VERT.
<b>ST/A4/H</b>	A4	HOR.
<b>ST/A3/V</b>	A3	VERT.
<b>ST/A3/H</b>	A3	HOR.

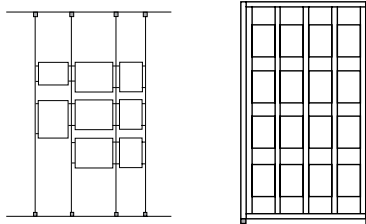

## SISTEMA DE CABLES Y TENSORES

**ESP.** Sistema de información de cables y tensores multifuncional. Mediante cables, carpetas de metacrilato y pinzas se puede componer el diseño deseado. Disponible en varios formatos y acabados.

## SISTEMA DE CABLES Y TENSORES

**ENG.** Multifunctional cable and tension displaying system. You can create your own design by disposing cables, methacrylate folders and pincers from the ceiling to the floor, or ceiling-suspended. Available in different formats and finishes.

## SYSTÈME DE CABLE ET POCLETTE

**FRA.** Information, publicité ou décoration sur câble acier, pinces, tablettes et pochettes en méthacrylate. Composez votre vitrine a votre image.



### CABLES Y TENSORES

REF	↓	
<b>2003/TS</b>	300	
<b>2003/TSC</b>	300	

### PINZAS DE SUJECCIÓN

REF	↓	
<b>2000/2</b>	0,4	
<b>2000/3</b>	0,4	

### RAIL DE DESPLAZAMIENTO

REF	└┘
<b>2001/C</b>	2,5 x 100
<b>2002/C</b>	2,5 x 200
<b>2003/C</b>	2,5 x 300

**ESP.** Conjunto formado por 1 pieza fija a techo, pared o rail en la parte superior, cable de acero de 3 m y pieza tensora inferior.

**ENG.** Cables can be fitted to suit all requirements—for wall to wall, floor to ceiling, 3m length. Cables secured to an end stop.

**FRA.** Kit composé de 1 support fixation au plafond, mur ou rail, 1 câble en acier 3 m., et un tendeur inférieur.

**ESP.** Pinzas mediante las cuales se sujetan las carpetas o estantes al cable tensor. Disponibles en múltiples formatos.

**ENG.** Single sided or double sided support grips to hold panels, shelves or boxes. Either fixed or rotating.

**FRA.** Pinces de fixation permettant la liaison du câble avec les pochettes porte-visuel, tablettes ou boîtes.

**ESP.** Perfil de aluminio anodizado. Se atornilla a techo, suelo o pared, y en su carril se fija el tensor. Permite desplazarse a der. e izq.

**ENG.** Anodized aluminium finish. Screw fixing into ceiling and/or floor and/or wall. The tensor allows the sliding to the left or right.

**FRA.** Finition aluminium anodisé. Fixation au plafond, au sol, u au mur, vis fournie. Déplacer librement l'ensemble des câbles.

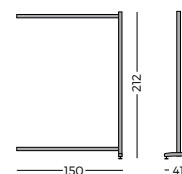
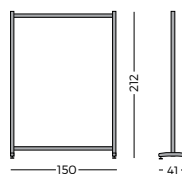
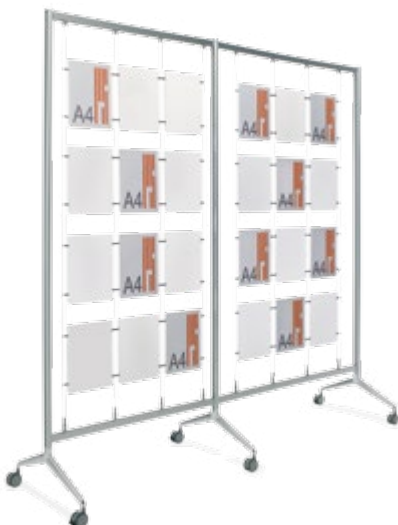

### BASTIDOR

REF	REF	└┘
<b>TN/90/R</b>	<b>TN/90/N</b>	212 x 90
<b>TN/110/R</b>	<b>TN/110/N</b>	212 x 110
<b>TN/150/R</b>	<b>TN/150/N</b>	212 x 150

### AMPLICIÓN

REF	REF	└┘
<b>TN/90/R</b>	<b>TN/90/N</b>	212 x 90
<b>TN/110/R</b>	<b>TN/110/N</b>	212 x 110
<b>TN/150/R</b>	<b>TN/150/N</b>	212 x 150



# 880

PANELES DE REJILLA  
GRID PANELS - PANNEAUX GRILLE

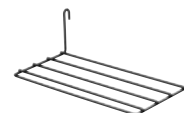
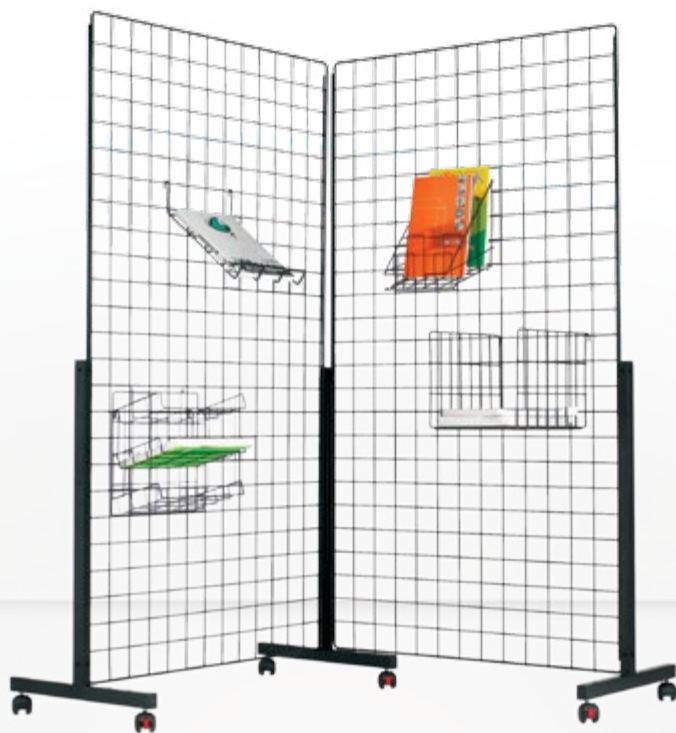
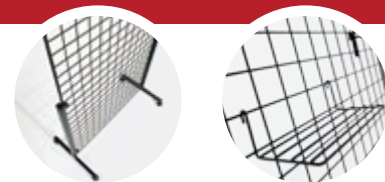

8801



8802

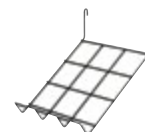

8803



8804



8808

REF	DESC.	L	H
880	Rejilla	180 x 100	0,5
881	Soporte	95 x 50	4

REF	DESC.	L	H
8801	Bandeja	9,5 x 30 x 14	0,5
8802	Estante	35 x 22 x 5	0,5
8803	Estante	5 x 27 x 38	0,5
8804	Revistero	29,5 x 22 x 24	0,5
8808	Gancho	9,5 x 3 x 27	0,5

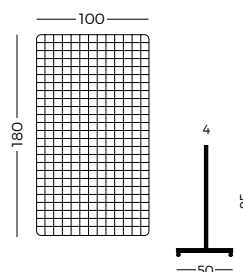

## PANELES REJILLA

**ESP.** Paneles rejilla metálicos de color negro, contruidos con varilla de hierro de 0,5 cm. formando una malla de 7 cm. Puede colgarse a la pared o montarse con pies forma "T" con ruedas. Sobre el panel podemos situar una extensa gama de accesorios.

## GRID PANELS

**ENG.** Black metallic grid panels which can be hung on walls or on "T" support frame (with castors). Black metallic stems have a diameter of 0,5 cm. and formed a 7 cm. net. Place a large range of accessories (also made with thin metallic stems).

## PANNEAUX GRILLE

**FRA.** Panneaux grille noir métallique en fer 0,5 cm. formant une cloison de 7 cm. Grande flexibilité de configuration. Fixation murale ou sur piètement "T" avec roulettes. Sur les panneaux on peut fixer très facilement une gamme étendue d'accessoires.





# CC-RAIL

RAIL PARA COLGAR CUADROS  
RAIL FOR PICTURE HANGING - RAIL POUR ACCROCHER DES TABLEAUX



REF	DESC.	L	H
CC/150	Rail	3 x 200	1
CC/1	Cable	200	1

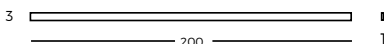

## RAIL PARA CUADROS

**ESP.** Rail de aluminio mural color plata mate, para colgar cuadros. Permite cambiarlos sin tener que atornillarlos en la pared. Ideales para salas, galerías de arte, recepciones, etc. El kit de 200 cm. incluye un juego de 2 cables.

## RAIL FOR PICTURE HANGING

**ENG.** Aluminium rail system for hanging up pictures on the wall. Matt silver colour. It enables different layout without drilling holes on the wall or using screws. Ideal for rooms,... The fixation kit includes two iron hooks and a set of two 200 cm cables.

## RAIL POUR DES TABLEAUX

**FRA.** Rail mural en aluminium pour suspendre et exposer des tableaux. Couleur argent mat. Ce système permet de changer facilement la composition de tableaux. Idéal pour des salles, des galeries d'art, des réceptions, etc

# DISPLAY

PORTAFOLLETOS DE METACRILATO  
DOCUMENT HOLDERS - PORTE-BRO-  
CHURES MÉTHACRYLATE



REF	┌	├	CAJA	U.
<b>A4/V3</b>	33 x 22	3,5	<b>A4/V3/5</b>	4
<b>A4/S</b>	30 x 22	3,5	<b>A4/S/10</b>	20
<b>A4/M</b>	24,5 x 22	3,5	<b>A4/M/10</b>	30

REF	┌	├	CAJA	U.
<b>A5/V3</b>	23 x 16	3,5	<b>A5/V3/5</b>	12
<b>A5/S</b>	20 x 16	3,5	<b>A5/S/10</b>	40
<b>A5/M</b>	16,5 x 16	3,5	<b>A5/M/10</b>	45

REF	┌	├	CAJA	U.
<b>A4/3/V3</b>	23 x 11	3,5	<b>A4/3/V3/5</b>	20
<b>A4/3/S</b>	20,5 x 11	3,5	<b>A4/3/S/10</b>	50
<b>A4/3/M</b>	16,5 x 11	3,5	<b>A4/3/M/10</b>	60

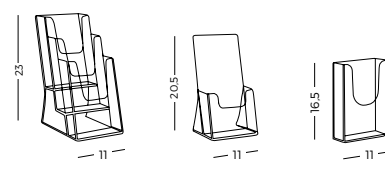
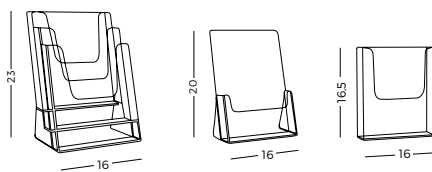
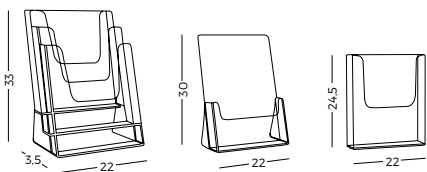

## PORTAFOLLETOS DE METACRILATO

**ESP.** Expositores para folletos fabricados en metacrilato transparente de alta resistencia. La diversidad de diseños; mural, sobremesa simple y sobremesa triple, permiten obtener un perfecto soporte para cada necesidad.

## DOCUMENT HOLDERS

**ENG.** High resistant transparent methacrylate document holders. Many different designs: wall, table and triple table that allow you to display all types of documents such as catalogues, brochures, cards for every need, etc.

## PORTE-BROCHURES MÉTHACRYLATE

**FRA.** Porte-Brochures fabriqués en PMMA transparent de haute résistance. Gamme très étendue de designs: usage mural, usage comptoir simple et triple pour tous les besoins.



# DISPLAY

DISPLAYS DE ACRÍLICO  
ACRYLIC DISPLAYS - PORTE-VISUELS ACRYLIC



**L**

REF	L	T
<b>BL/EX/0012</b>	29,7 x 21	A4
<b>BL/EX/0014</b>	21 x 14,8	A5

**T**

REF	L	T
<b>BL/EX/0032</b>	29,7 x 21	A4
<b>BL/EX/0034</b>	21 x 14,8	A5

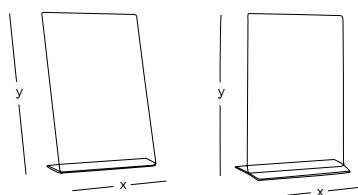

## DISPLAY DE ACRÍLICO

**ESP.** Gama de portadocumentos fabricados en acrílico transparente de alta resistencia. Disponibles en formato "T" y "L" y cada uno de ellos en tamaño A4 y A5.

## DISPLAYS ACRYLIC

**ENG.** Range document holder made of high strength transparent acrylic. Available as "T" and "L" and each of them in A4 and A5.

## DISPLAY ACRYLIQUE

**FRA.** Gamme de supports et porte-documents en acrylique transparent de haute résistance. Disponible en "T" et "L" et disponibles en formats A4 et A5.

# **MODULPLAN**

MOBILIARIO AUXILIAR  
AUXILIAR FURNITURE  
MOBILIER AUXILIAIRE



# 6000

PAPELERAS BASIC  
BASIC BINS - CORBEILLES BASIC



REF	L	L
6001	31 x ø21,5	12
6002	31 x ø25,5	16
6003	39,5 x ø29,5	27

**COLOR**

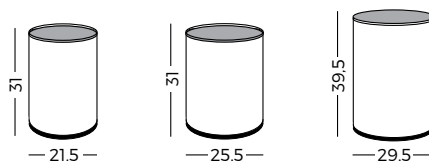

**PAPELERA BASIC**

**ESP.** Gama de papeleras metálicas lisas pintadas epoxi, provistas de aro inferior de PVC. Disponibles en 12, 16 y 27 litros. Color standard gris RAL 7035. Bajo pedido ver gama de colores.

**BASIC BINS**

**ENG.** Smooth metal wastebaskets Range epoxy painted, fitted with PVC bottom ring. Available in 12, 16 and 27 liters. Standard colour gray RAL 7035. Ask us for a special colour.

**CORBEILLES BASIC**

**FRA.** Gamme de corbeille à papier en métal époxy peint, équipée d'un anneau inférieure en PVC. Disponible en 12, 16 et 27 litres. Couleur standard gris RAL 7035. Consultez nous pour un coloris spécial.



# 6023

PAPELERA METÁLICA IGNÍFUGA  
METALLIC FIREPROOF WASTEPAPER BIN - CORBEILLE IGNIFUGE EN MÉTAL



## COLOR



REF	L	L
<b>6022</b>	35 x ø27,5	21
<b>6023</b>	65 x ø27,5	39

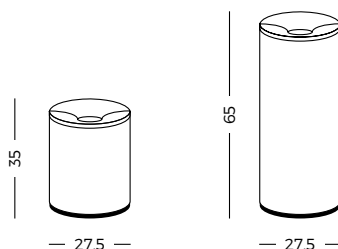

## PAPELERA METÁLICA IGNÍFUGA

**ESP.** Papelera ignífuga de diferentes medidas. Debido a la forma del cabezal, el fuego generado en el interior se extingue rápidamente. En chapa metálica. Color standard gris RAL 7035. Bajo pedido ver gama de colores.

## FIREPROOF WASTEPAPER BIN

**ENG.** Fire-retardant bin in different sizes. Due to the shape of the lid, the fire generated inside extinguishes itself quickly. Made from metal sheet. Standard colour gray RAL 7035. Ask us for a special colour.

## CORBEILLE IGNIFUGE

**FRA.** Poubelle ignifuge de différentes mesures. En raison de la forme du couvercle, le feu généré à l'intérieur s'éteint rapidement. Fabriqué à partir de tôle. Couleur standard gris RAL 7035. Consultez nous pour un coloris spécial.

# 6056

PAPELERAS CÚBICAS  
CUBIC WASTEPAPER BINS - CORBEILLE EN MÉTAL



REF	L	→	L
6056/1	40 x 30	30	36
6056/2	60 x 30	30	54
6056/3	80 x 30	30	72

COLOR



/BL

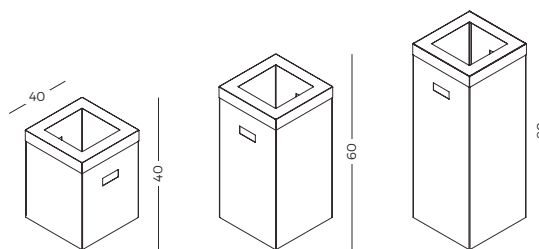

## PAPELERA METÁLICA

**ESP.** Papelera sencilla de chapa metálica en 3 alturas para diferentes espacios. 40, 60 y 80 cm. Color standard blanco RAL 9003. Bajo pedido ver gama de colores.

## METALLIC WASTEPAPER BIN

**ENG.** Simple sheet metal bin in 3 heights for different spaces. 40, 60 and 80 cm. Standard colour white RAL 9003. Ask us for a special colour.

## CORBEILLE EN MÉTAL

**FRA.** Corbeille métallique simple de 3 hauteurs pour tous type d'espaces. 40, 60 et 80 cm. Couleur standard blanc RAL 9003. Consultez nous pour un coloris spécial.





# SWING

PAPELERA METÁLICA  
METALLIC WASTEPAPER BIN - CORBEILLE EN MÉTAL



## COLOR



• /BL

REF	L	→	L
<b>6030</b>	65 x 31,5	26	41
<b>6031</b>	83 x 31,5	26	56

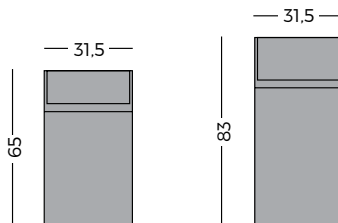

## PAPELERA METÁLICA "SWING"

**ESP.** Papelera con apertura batiente de mediana capacidad ideal para centros comerciales. Disponible en INOX bajo pedido para exterior. Disponible 2 tamaños. Cabezal basculante.

## METALLIC WASTEPAPER BIN "SWING"

**ENG.** Wastepaper bin with swing-open door of medium capacity. Ideal for shopping center. INOX version available for outdoors. 2 sizes available.

## CORBEILLE "SWING" EN MÉTAL

**FRA.** Corbeille avec ouverture battante de capacité moyenne. Idéale centres commerciaux. Version INOX disponible pour l'extérieur. Disponible en 2 dimensions.

# 6055

PAPELERA DE 3 RESIDUOS  
RECYCLING CONTAINER - CONTENEUR DE RECYCLAGE



REF	L	→	L
6055	70 x 75	35	120

COLOR

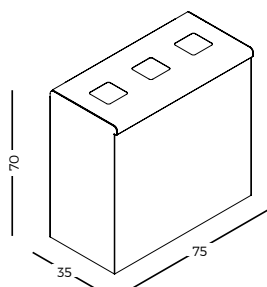

## CORBILLE EN MÉTAL

**ESP.** Contenedor de reciclaje de 120 L de 3 residuos, con tapa abatible y 3 aros interiores para sujeción de las bolsas. Tapa superior con vinilo para la diferenciación de los residuos. Color standard blanco RAL 9003. Bajo pedido ver gama de colores.

## RECYCLING CONTAINER

**ENG.** 120L recycling container for 3 types of waste, with hinged lid with pictogram for the different types of waste. Standard colour white RAL 9003. Ask us for a special colour.

## CONTENEUR DE RECYCLAGE

**FRA.** Conteneur de recyclage de 120 L de 3 résidus, avec couvercle à charnière et 3 anneaux intérieurs pour la fixation des sacs. Couvercle supérieur avec pictos pour la différenciation des déchets.



# 6045

PAPELERA DE RECICLAJE  
RECYCLE BINS - CORBEILLE DE RECYCLAGE



## COLOR



/AZ /VD /AM

REF	L	↑	L
6045	26 x 36,5	81	76

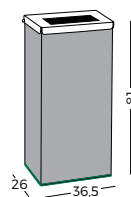
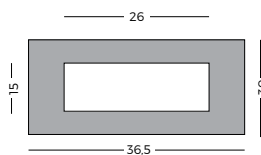

## PAPELERA DE RECICLAJE

**ESP.** Papelera de reciclaje gris de 76 litros, con tapa abatible y aro interior para bolsa. Tapa superior disponible en 3 colores de reciclaje básicos. Ideal para oficinas, centros comerciales, etc...

## RECYCLE BINS

**ENG.** Recycle Bin 76 liters grey colour, with hinged lid and inner ring for bag. Top cover available in 3 basic colours recycling. Ideal for offices, shopping malls, etc ...

## CORBEILLE DE RECYCLAGE

**FRA.** Corbeille de recyclage de 76 litres, avec couvercle à charnière et bague intérieure pour le sac. Le couvercle est disponible en 3 couleurs de base de recyclage. Idéale pour les bureaux, les centres commerciaux...

# 6050

PAPERERAS DE PEDAL  
 PEDAL BINS - CORBEILLES À PÉDALE



REF	L	L
6050/I	32 x ø21	5
6051/I	39 x ø25	12
6052/I	45 x ø30	20
6053/I	61 x ø30	30

ACABADO

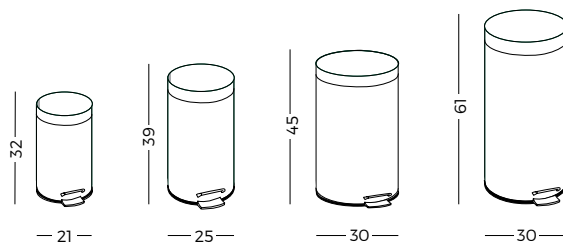

## PAPERERAS DE PEDAL

**ESP.** Gama de papeleras metálicas con apertura de pedal. Incorporan cubeta de plástico con asa y están disponibles en 5, 12, 20 y 30 litros. Acero inoxidable.

## PEDAL BINS

**ENG.** Range of metal bins with pedal opening. Incorporating plastic bucket and handle are available in 5, 12, 20, and 30 liters. Stainless steel.

## CORBEILLES À PÉDALE

**FRA.** Gamme de corbeilles métalliques avec ouverture par pédale. Un seau en plastique intérieur avec poignée est disponibles en 5, 12, 20 et 30 litres. Acier inoxydable.



# BL/MO

CENICEROS PARA EXTERIOR  
OUTDOOR ASHTRAYS - CENDRIERS D'EXTÉRIEUR



BL/MO/0051



BL/MO/0050

REF	L	H	L
BL/MO/0052	100 x 45	25	4.43

REF	L	H	L
BL/MO/0050	25 x 19	25	1.48
BL/MO/0051	35 x ø9	25	0.68

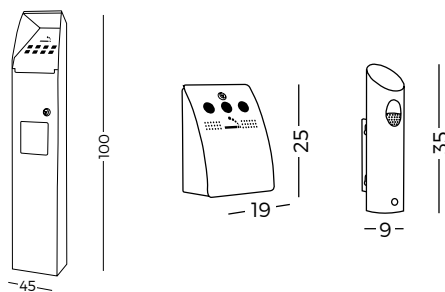

## CENICEROS PARA EXTERIOR

**ESP.** Gama de ceniceros de exterior. 3 modalidades a suelo o a pared todos ellos provistos con cerradura de seguridad. Ideal para situar en las entradas de espacios públicos y privados donde no está permitido fumar.

## PEDAL BINS

**ENG.** Range of outdoor ashtrays. 3 models, for floor or wall all provided with security lock. Ideal for entries and in public or private spaces where smoking is not permitted.

## CORBEILLES À PÉDALE

**FRA.** Gamme de cendriers d'extérieurs. 3 modèles de sol ou mural tous fournis avec serrure de sécurité. Idéal pour les entrées dans les espaces publics et privés où fumer est interdit.



# 6120

PERCHEROS DE PARED  
COAT RACKS - PORTE-MANTEAUX



REF	L	H	●
6120/3	10 x 41	2,5	3
6120/4	10 x 55	2,5	4
6120/6	10 x 85	2,5	6
6120/6R	24 x 81	2,5	6

COLOR

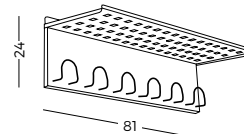
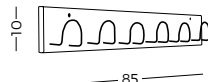
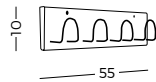
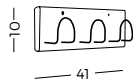

### PERCHEROS DE PARED

**ESP.** Colección de percheros murales metálicos pintados epoxi gris. Diferentes tamaños y disponible en 3, 4 y 6 perchas. Ideales tanto para el mundo de la oficina como el habitat.

### COAT RACKS

**ENG.** Wall racks collection painted in grey epoxy. Different sizes and available in 3,4 and 6 hangers. Ideal as to the world of office as the habitat...

### PORTE-MANTEAUX

**FRA.** Gamme de portes manteaux métalliques finition en époxy gris. Différentes dimensions, avec 3,4 et 6 crochets. Idéal pour les bureaux et l'habitat.



# ECO/T

PERCHEROS  
COAT STAND - PORTE-MANTEAU



## COLOR



/NG /BL

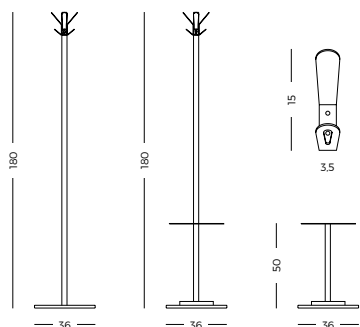

## PERCHERO METÁLICO

**ESP.** Perchero metálico de tubo redondo de  $\phi 4$ cm. y de gran ligereza y estabilidad gracias a su base. 4 ganchos dobles en su parte superior y pintados en colores negro y blanco. Ideal para la oficina y el habitat. Disponible en versión mural de 1, 3,4 o 6 perchas.

## METALLIC COAT STAND

**ENG.** Metal coat stand with round tube  $\phi 4$ cm. and of great lightness and stability thanks to its base. 4 double hooks on top and painted in black and white colors. Ideal for the office and habitat. Available in wall version of 1, 3,4 or 6 hangers.

## PORTE-MANTEAU MÉTALLIQUE

**FRA.** Porte-manteau en métal avec tube rond de  $\phi 4$ cm, de grande légèreté et stabilité grâce à sa base ronde lestée. 4 crochets doubles sur le dessus peint de couleur noir ou blanc. Idéal pour le bureau et l'habitat. Disponible en version murale de 1, 3, 4 ou 6 patères.

REF	DESC.	L	●
EC/02	Perchero	180 x $\phi 36$	8
EC/12	Perchero - Paragüero	180 x $\phi 36$	8
EC/P	Paragüero	50 x $\phi 36$	-
EC/02/M1	Perchero mural	15 x 3,5	1
EC/02/M3	Perchero mural	15 x 20,5	3
EC/02/M4	Perchero mural	15 x 29	4
EC/02/M6	Perchero mural	15 x 42,5	6





# PERCHEROS

PERCHEROS  
COAT STANDS - PORTE-MANTEAUX



REF	L	●	COLOR
6100	177 x ø38	8	/GR
6110	165 x ø30	5	/GR
EC/03	177 x ø38	3	/BL - /NG



### COLOR

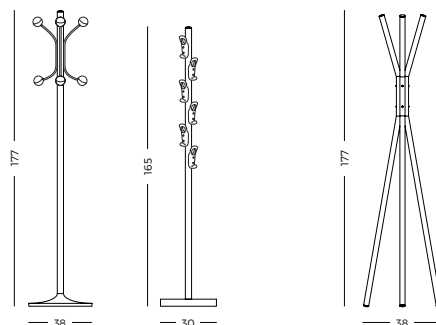

### PERCHEROS METÁLICOS

**ESP.** Gama de percheros metálicos de tubo redondo. 6100 y 6110 en base redonda, con 8 y 6 perchas superiores respectivamente. EC/03 es desmontable, en tubo redondo doblado.

### METALLIC COAT STANDS

**ENG.** Range of metal round coat stands. 6100 and 6110 in round base, with 8 and 6 upper hangers respectively. EC/03 in 3 round bent tubes.

### PORTE-MANTEAUX MÉTALLIQUES

**FRA.** Gamme de portemanteaux ronds en métal. 6100 et 6110 dans la base ronde, avec 8 et 6 cintres supérieurs, respectivement. EC/03 en 3 tubes coudés ronds.





# ECO/T

PERCHEROS  
COAT STAND - PORTE-MANTEAU



## COLOR



/NG /BL

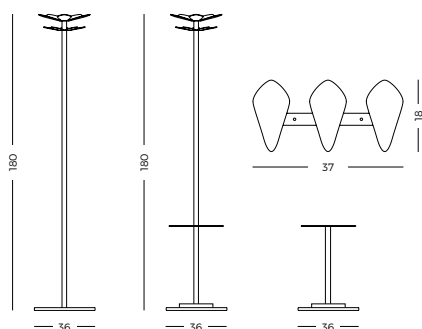

REF	DESC.	L	●
<b>EC/04</b>	Perchero	180 x ø36	10
<b>EC/14</b>	Perchero - Paragüero	180 x ø36	10
<b>EC/P</b>	Paragüero	50 x ø36	-
<b>EC/04/M3</b>	Perchero mural	18 x 37	3
<b>EC/04/M4</b>	Perchero mural	18 x 51	4
<b>EC/04/M6</b>	Perchero mural	18 x 79	6

## PERCHERO METÁLICO

**ESP.** Perchero metálico de tubo redondo de ø3cm, ligero y estabilidad gracias a su base. 10 perchas en su parte superior. Pintado en colores negro y blanco. Disponible en versión mural de 3, 4 o 6 perchas.

## METALLIC COAT STAND

**ENG.** Metallic coat rack with round ø3cm tube, light and stable thanks to its base. 10 hangers on top. Painted in black and white colors. Available in wall version of 3, 4 or 6 hangers.

## PORTE-MANTEAU MÉTALLIQUE

**FRA.** Porte-manteau métallique fabriqué avec un tube rond de ø3cm, léger et stable grâce à sa base lestée. 10 patères sur le dessus. Couleur noire ou blanche. Disponible en version murale de 3, 4 ou 6 patères.



# TS

PERCHEROS DE BASTIDOS  
COAT RACKS - PORTE-MANTEAUX



REF	L	↑	⇄
TS/PER/MT	200 x 65	25	4,5
TS/PER/MX	200 x 62	25	4,5

REF	L	↑	⇄
TS/BUR/R	174 x 120	53	4,5

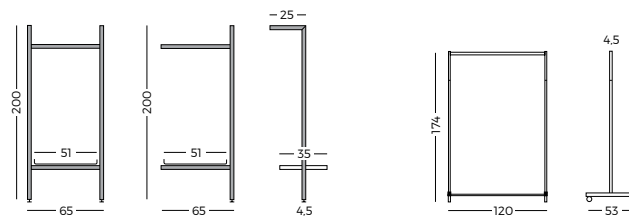

## PERCHEROS DE PARED

**ESP.** Percheros fabricados con perfil de aluminio pata mate. TS/PER se fija a la pared mediante los brazos separadores y se apoya al suelo. Disponible kit de ampliación: Ref. TS/PER/MX. TS/BUR/R es un bastidor con ruedas demontable.

## COAT HANGERS

**ENG.** Coat hanger in grey aluminium. TS/PER fixed to the wall and floor. Hanging rod for hangers and lower tray for bags or helmets included. Extension kit available. TS/BUR/R with casters and removable.

## PORTE-MANTEAUX

**FRA.** Porte-manteux en aluminium. TS/PER avec un point de fixation mural et appui au sol sur piétement. Kit d'extension disponible. Barre de suspension pour cintres et tablette inférieure pour sacs et casques inclus. TS/BUR/R sur roulettes et amovible.

PERCHEROS DE BASTIDOS  
COAT RACKS - PORTE-MANTEAUX



REF	L	↑	⇄
TS/PER/R	174 x 120	53	4,5
TS/PER/RB	174 x 120	53	4,5

REF	DESC.	↑
PER/I	Percha	17 x 40

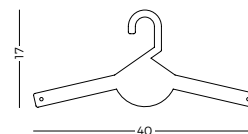
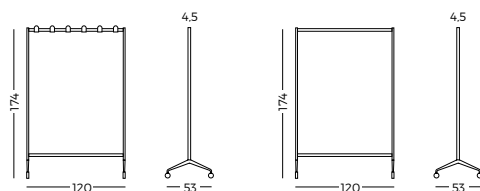

**PERCHEROS DE PARED**

**ESP.** Perchero con ruedas (2 con freno) fabricados con perfil de aluminio anodizado plata mate TEN. El perchero incluye 6 brazos dobles (12 perchas) y 2 bases de plexiglass blanco en la parte inferior.

**COAT HANGERS**

**ENG.** Coat hanger TEN made from anodized aluminium on casters with brakes. 6 double pegs (12 total) and 2 lower trays made from plexiglass.

**PORTE-MANTEAUX**

**FRA.** Portemanteau sur roulettes (dont 2 avec frein) en aluminium anodisé TEN. 6 patères doubles et 2 tablettes inférieures pour sacs et casques en plexiglass.

# TEN

SISTEMA DE ESTANTERÍA  
SHELF MODULAR SYSTEM - ETAGÈRE MODULAIRE SYSTEM



REF	DESC.	L	H
TS/242/P	Aluminio	220 x 25	-
TS/242/EI	Estante	35 x 66,5	0,2

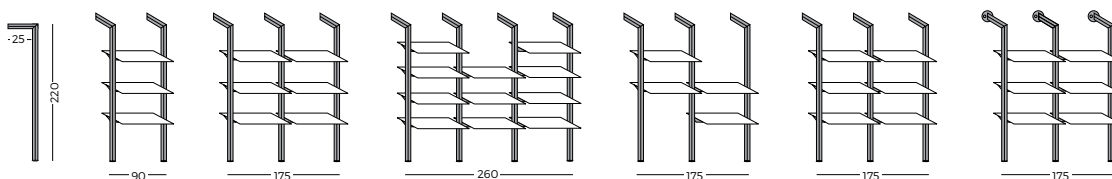

## SISTEMA DE ESTANTERÍA "TEN"

**ESP.** Perfilera de aluminio anodizada plata mate para equipar comercios, vestidores, oficinas, etc... Gracias a su modularidad permite confeccionar estantería de la medida deseada. Se compone de perfil vertical, juego de soportes graduable y estantes.

## MODULAR SYSTEM "TEN"

**ENG.** Modular shelf in anodized aluminium. Ideal for offices, shops, cloakrooms...(various layouts possible). Composed of a vertical profile with wall fixation and a set of brackets. Various colors and finishings.

## ETAGÈRE MODULAIRE SYSTEM "TEN"

**FRA.** Etagère modulaire en aluminium anodisé "Ten", idéale pour les bureaux, commerces, vestiaires... (nombreuses configurations possibles). Composée d'un profil vertical avec fixation murale, d'un jeu de pattes de fixation réglables, diverses finitions et couleurs.



# TROLLEY

MESAS DE PROYECCIÓN  
PROJECTOR TROLLEYS - TABLES DE RÉTRPROJECTION



**COLOR**



REF	L	↑	↓
MM	60 x 55	60/95	1,9
MP	60 x 55	60/95	1,9

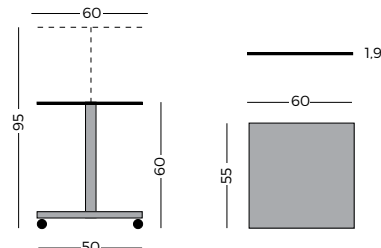
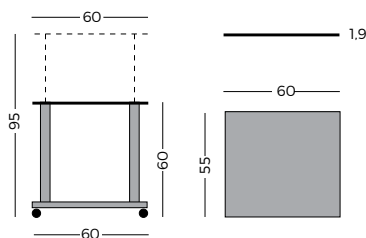

**MESAS DE PROYECCIÓN**

**ESP.** Mesa de proyección cómoda y ligera, con ruedas multidireccionales, provistas de freno las delanteras. Toda la gama de mesas tienen la estructura metálica pintada en color gris, y los tableros son de madera melaminada.

**PROJECTOR TROLLEYS**

**ENG.** With a modern design suitable for all OHPs, this functional grey metallic mobile trolley features a laminated tabletop for storage of accessories and equipment, and 4 fully circular castors (lockable front castors).

**TABLES DE RÉTRPROJECTION**

**FRA.** Table de projection légère et stable. Conception en métal gris et plateau en mélaminé. Equipée de 4 roulettes pivotantes dont 2 avec freins, qui assurent mobilité et stabilité. Plateau télescopique réglable en hauteur. Idéale pour n'importe quel type de projecteur.

# PFA

PANELES FONOABSORBENTES  
SOUND ABSORBING PANELS - TABLEUX PHONO-ABSORBANTS

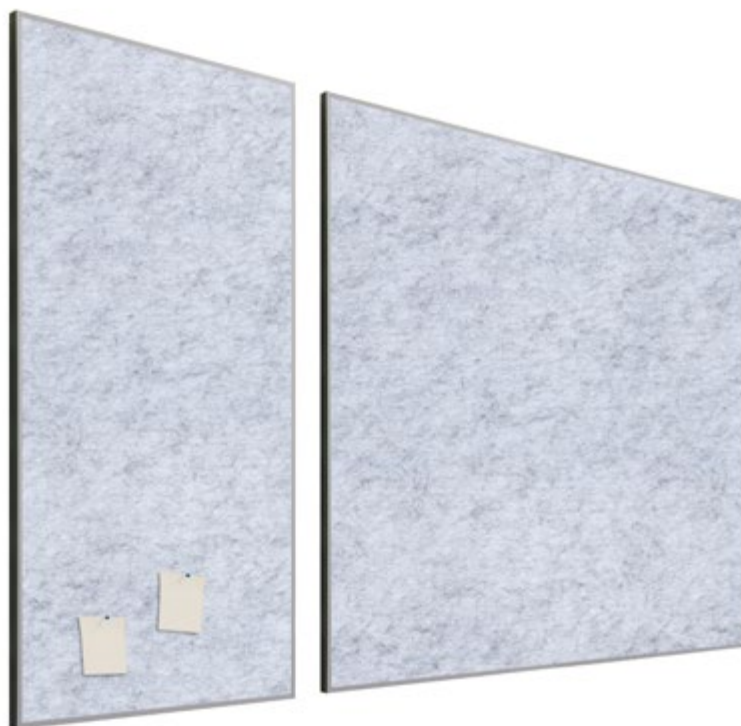

REF	L	H	alpha m
PFA/1	30 x 60	2,3	0,25
PFA/2	60 x 60	2,3	0,25
PFA/3	60 x 120	2,3	0,25
PFA/4	120 x 120	2,3	0,25

COLOR

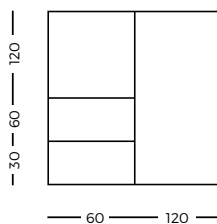

**PANELES FONOABSORBENTES**

**ESP.** Panel fonoabsorbente enmarcado con perfil de aluminio anodizado Mini en color plata mate. Fabricado con alto porcentaje de material reciclado: 60% fibras de poliéster reciclado de botellas de plástico PET y 40% de nuevas fibras de poliéster. Propiedades acústicas: alpha m: 0,25. NRC: 0,30.

**SOUND-ABSORBING PANELS**

**ENG.** Sound-absorbing panel framed with anodised aluminum profile Mini in matt silver. Manufactured with a high percentage of recycled material: 60% polyester fiber recycled from PET plastic bottles and 40% new polyester fibers. Acoustic properties: alpha m: 0,25. NRC: 0,30.

**TABLEUX PHONO-ABSORBANTS**

**FRA.** Panneau insonorisant fabriqué avec un pourcentage élevé de matériaux recyclés: 60% de fibres de polyester recyclées provenant de bouteilles en plastique PET et 40% de fibres de polyester neuves. Propriétés acoustiques: alpha m: 0,25. NRC: 0,30.



# PFA

PANELES FONOABSORBENTES  
SOUND ABSORBING PANELS - TABLEAUX PHONO-ABSORBANTS



REF	DESC.	L	H	alpha m
PFA/C2	Techo	60 x 60	0,9	0,25
PFA/S3	Suspendido	60 x 60	2,3	0,25
PFA/S4	Suspendido	120 x 60	2,3	0,25

COLOR

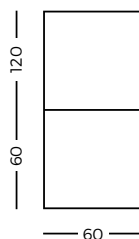

**PANELES FONOABSORBENTES**

**ESP.** Panel fonoabsorbente para techo o suspendido. Fabricado con alto porcentaje de material reciclado: 60% fibras de poliéster reciclado de botellas de plástico PET y 40% de nuevas fibras de poliéster. Propiedades acústicas: alpha m: 0,25. NRC: 0,30.

**SOUND-ABSORBING PANELS**

**ENG.** Sound-absorbing panel for the ceiling or suspended. Manufactured with a high percentage of recycled material: 60% polyester fiber recycled from PET plastic bottles and 40% new polyester fibers. Acoustic properties: alpha m: 0,25. NRC: 0,30.

**TABLEAUX PHONO-ABSORBANTS**

**FRA.** Panneau insonorisant fabriqué avec un pourcentage élevé de matériaux recyclés: 60% de fibres de polyester recyclées provenant de bouteilles en plastique PET et 40% de fibres de polyester neuves. Propriétés acoustiques: alpha m: 0,25. NRC: 0,30.





# PFA

PANELES FONOABSORBENTES  
SOUND ABSORBING PANELS - TABLEAUX PHONO-ABSORBANTS



## COLOR



/NG /AN /GR /NJ /AM /AZ /VD

REF	W	L	H	alpha m
PFA/T3	190	60 x 120	53	0,25
PFA/T4	190	120 x 120	53	0,25

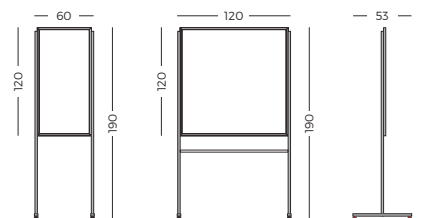

## PANELES FONOABSORBENTES

**ESP.** Panel fonoabsorbente enmarcado con perfil de aluminio anodizado Mini en color plata mate y con soporte T. Fabricado con alto porcentaje de material reciclado: 60% fibras de poliéster reciclado de botellas de plástico PET y 40% de nuevas fibras de poliéster. Propiedades acústicas: alpha m: 0,25. NRC: 0,30.

## SOUND-ABSORBING PANELS

**ENG.** Sound-absorbing panel framed with anodised aluminum profile Mini in matt silver with T support. Manufactured with a high percentage of recycled material: 60% polyester fiber recycled from PET plastic bottles and 40% new polyester fibers. Acoustic properties: alpha m: 0.25. NRC: 0.30.

## TABLEAUX PHONO-ABSORBANTS

**FRA.** Panneau insonorisant avec support T fabriqué avec un pourcentage élevé de matériaux recyclés: 60% de fibres de polyester recyclées provenant de bouteilles en plastique PET et 40% de fibres de polyester neuves. Propriétés acoustiques: alpha m: 0.25. NRC: 0.30.

# LIMIT

MAMPARA MODULAR  
MODULAR PARTITION - CLOISON MODULAIRE

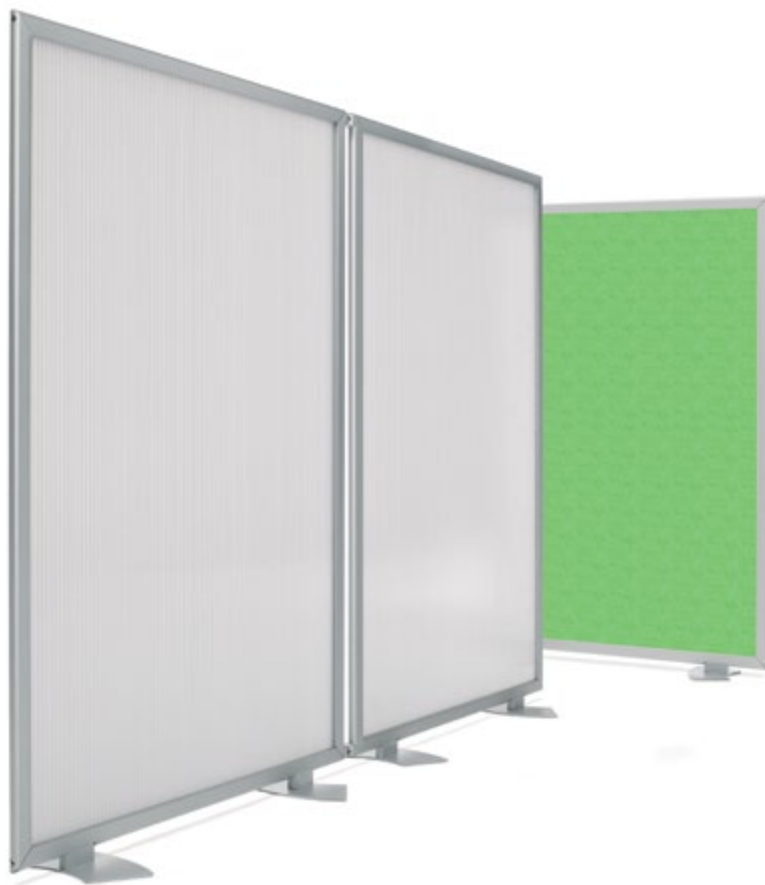

REF	L	H	+
300/1/...	120 x 100	122	2
300/2/...	150 x 100	152	2
300/3/...	180 x 100	182	2

REF	L	H
300/K	2 x 5	2
300/K/4	5 x 5	4

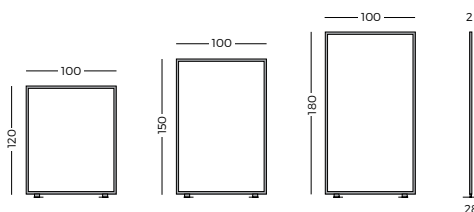

## MAMPARA MODULAR "LIMIT"

**ESP.** Mampara modular "Limit" fabricada con perfil de aluminio anodizado mate y pies trapezoidales metálicos pintados en gris. Graduable con apertura de grados necesaria. Disponible en pizarra lacada blanca rotulable, policarbonato acanalado y panel acústico disponible en 7 colores.

## MODULAR PARTITION "LIMIT"

**ENG.** Modular partition with aluminium structure and metallic supports. Different layouts possible: in a line or in staggered rows... Available with lacquered whiteboard, corrugated polycarbonate and available in 7 colours of acoustic panel.

## CLOISON MODULAIRE "LIMIT"

**FRA.** Cloison modulaire avec structure en aluminium et pieds métalliques. Modulable pour configurations en ligne, en quinconce... Disponible en finition tableau blanc laqué, polycarbonate rainuré et disponible en 7 couleurs de panneau acoustique..



### PIZARRA

REF	L	--	- -
<b>300/1/PI</b>	120 x 100	122	2
<b>300/2/PI</b>	150 x 100	152	2
<b>300/3/PI</b>	180 x 100	182	2



### FONOABSORBENTE

REF	L	--	- -
<b>300/1/FA</b>	120 x 100	122	2
<b>300/2/FA</b>	150 x 100	152	2
<b>300/3/FA</b>	180 x 100	182	2



### POLICARBONATO

REF	L	--	- -
<b>300/1/PX</b>	120 x 100	122	2
<b>300/2/PX</b>	150 x 100	152	2
<b>300/3/PX</b>	180 x 100	182	2



**ESP.** Crea espacios dentro de la oficina para poder crear un ambiente de trabajo adecuado.

**ENG.** Design spaces within the office to creating a suitable work environment.

**FRA.** Créez des espaces afin d'adapter et créer des ambiances de travail différentes.

### FONOABSORBENTE



NEGRO /NG



ANTRACITA /AN



BLANCO /GR



NARANJA /NJ



VERDE /VD



AMARILLO /AM



AZUL /AZ

### ACABADOS



PIZARRA /PI



POLICARB. /PX

# TEN-LIMIT

MAMPARA MODULAR  
MODULAR PARTITION - CLOISON MODULAIRE



REF	L	↑	↑↑
TL/150/...	150 x 100	175	4,5
TL/180/...	180 x 100	205	4,5

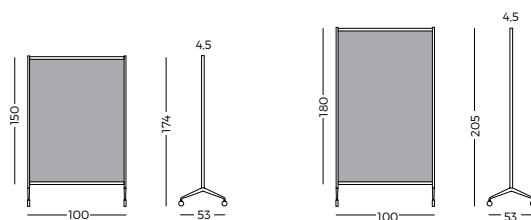

## MAMPARA TEN-LIMIT

**ESP.** Sistema de mampara modular fabricada con perfil de aluminio color plata y estructura provista de pies de fundición con ruedas y freno. Disponible en pizarra lacada blanca rotulable, policarbonato acanalado y panel acústico disponible en 7 colores.

## TEN-LIMIT PARTITION SYSTEM

**ENG.** Modular partition system made of silver gray aluminium profile and a structure with cast feet fitted with wheels and brakes. Available with lacquered whiteboard, corrugated polycarbonate and available in 7 colours of acoustic panel.

## CLOISON TEN-LIMIT

**FRA.** Système de cloison modulaire sur cadre en aluminium et pieds en fonte gris, équipés de roulettes et de freins. Disponible en finition tableau blanc laqué, polycarbonate rainuré et disponible en 7 couleurs de panneau acoustique.



**PIZARRA**

REF	L	↑	±
TL/150/PI	150 x 100	175	4,5
TL/150/XF/PI	150 x 100	175	4,5
TL/180/PI	180 x 100	205	4,5
TL/180/XF/PI	180 x 100	205	4,5



**FONOABSORBENTE**

REF	L	↑	±
TL/150/FA	150 x 100	175	4,5
TL/150/XF/FA	150 x 100	175	4,5
TL/180/FA	180 x 100	205	4,5
TL/180/XF/FA	180 x 100	205	4,5



**POLICARBONATO**

REF	L	↑	±
TL/150/PX	150 x 100	175	4,5
TL/150/XF/PX	150 x 100	175	4,5
TL/180/PX	180 x 100	205	4,5
TL/180/XF/PX	180 x 100	205	4,5



**ESP.** Crea espacios dentro de la oficina para poder crear un ambiente de trabajo adecuado.

**ENG.** Design spaces within the office to creating a suitable work environment.

**FRA.** Créez des espaces afin d'adapter et créer des ambiances de travail différentes.

**FONOABSORBENTE**



NEGRO /NG



ANTRACITA /AN



BLANCO /GR



NARANJA /NJ



VERDE /VD



AMARILLO /AM



AZUL /AZ

**ACABADOS**



PIZARRA /PI



POLICARB. /PX

# 750

MAMPARA MODULAR  
MODULAR PARTITION - CLOISON MODULAIRE

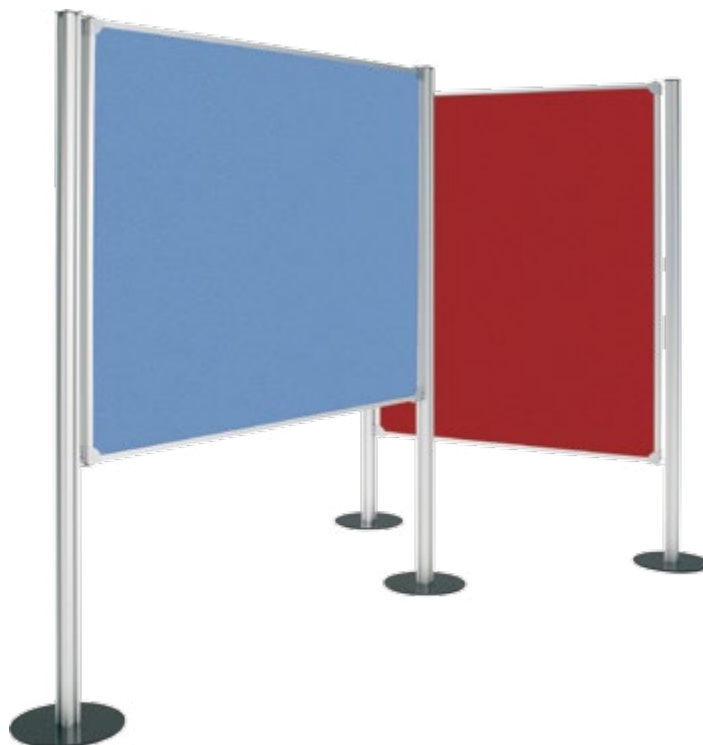

## TAPIZADO



/NG /GR /CR /OC /NJ /RJ /BD /AZ /AC /VC /VM /VD

REF L H

750/... 120 x 150 3,5



## ACABADO



CORK PIZARRA

REF L H

770/10 190 x ø36 5

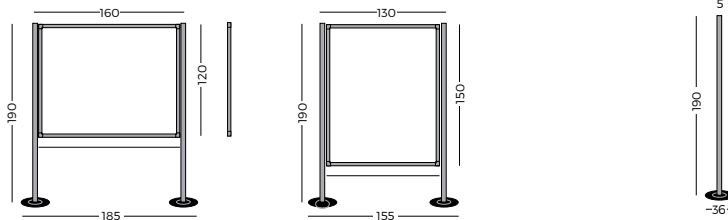

## MAMPARA MODULAR 750

**ESP.** Mampara modular muy ligera, construida con un núcleo central de nido de abeja, enmarcada con perfil de aluminio con cantoneras de color gris. Disponible en pizarra lacada blanca rotulable, corcho y tapizado. Amplia gama de aplicaciones como: Exposiciones, ferias, convenciones, etc.

## 750 PARTITION SYSTEM

**ENG.** Light modulated felt boards with aluminium frame, grey corners and honeycomb wood. Variety of applications, such as expositions, fairs, conventions, etc... Boards are 120 x 150 cm. and you can mount the support vertically or horizontally.

## CLOISONS MODULAIRES 750

**FRA.** Cloison modulaire très légère fabriquée en carton nid d'abeille, avec encadrement en aluminium et coins en plastique gris. 120 x 150. Montage et transport facile. Idéale pour les expositions, séparations d'espaces, foires, conventions, etc...



**PIZARRA**

**REF** L H

**750/P** 120 x 150 3.5



**TAPIZADO**

**REF** L H

**750/T** 120 x 150 3.5



**CORCHO**

**REF** L H

**750/C** 120 x 150 3.5



**COMBINACIONES**

Bajo pedido - Under order - Sous commande

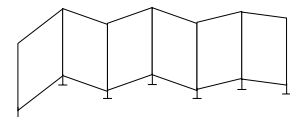
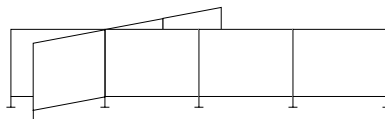
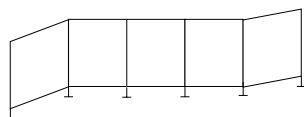

# SEP

SEPARADOR DE ESCRITORIO  
DESKTOP SEPARATOR - SÉPARATEURS DE BOUREAU



REF	L	H
SEP/FA/80	40 x 80	4,6
SEP/FA/120	40 x 120	4,6
SEP/FA/140	40 x 140	4,6
SEP/FA/160	40 x 160	4,6
SEP/FA/180	40 x 180	4,6
SEP/FA/200	40 x 200	4,6

**COLOR**

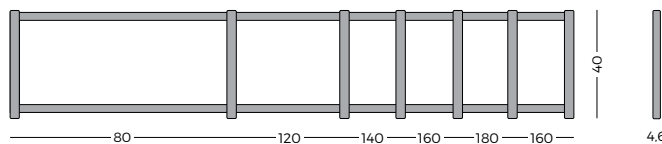

\* Sujeción (x2)

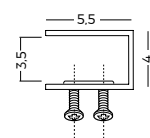

**SEPARADOR DE ESCRITORIO**

**ESP.** Colección de separadores de sobremesa acústicos tapizados con tela disponible en 6 colores. Perfil de aluminio anodizado plata mate. Conjunto fonoabsorbente.

**DESKTOP SEPARATOR**

**ENG.** Collection of acoustic desktop separators with 6 different colours of fabric. Profile of anodized aluminium matt silver. Sound absorbing assembly.

**SÉPARATEURS DE BOUREAU**

**FRA.** Collection de cloisons et séparateurs acoustiques de bureau, disponible en toile avec 6 couleurs au choix. Profil en aluminium mat anodisé argent mat, avec ensemble amortissant.





# ATR

ATRIL PARA CONFERENCIAS  
CONFERENCE LECTERNS - PUPITRE POUR CONFÉRENCES



REF	L	↑
ATR/1	51 x 31	122
ATR/2	45 x 32	110

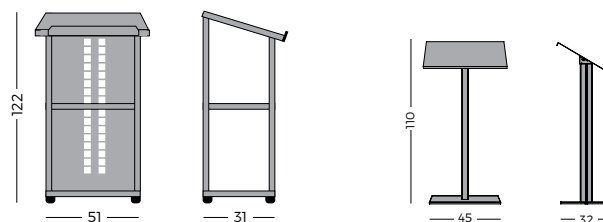

## ATRIL PARA CONFERENCIAS

**ESP.** Atriles para conferencias. ATR/1 fabricado con estructura de aluminio anodizado en plata mate y plancha perforada del mismo color. El sobre inclinado, la base y el estante son de madera de haya. La base incluye 4 niveladores regulables en altura. ATR/2 fabricado en chapa de hierro y aluminio anodizado.

## CONFERENCE LECTERN

**ENG.** Conference lecterns. ATR/1 made from silver aluminium anodized structure and perforated plate in the same colour. The inclined top, base and shelf are made of beech wood. The base contains 4 height adjustable levelings to level out the ground drops. ATR/2 made from iron sheets and anodized aluminium.

## PUPITRE POUR CONFÉRENCES

**FRA.** Pupitres de conférences. ATR/1 fabriqué avec une structure en aluminium anodisée de couleur argent mat. La tablette inclinée ainsi que la base sont en bois d'hêtre. La base à 4 niveleurs réglables en hauteur. Idéal pour les salles de formation et de conventions. ATR/2 structure métallique et aluminium anodisé.

# VTR

VITRINAS DE PIÉ  
VITRINA DE PIE -VITRINA DE PIE



REF	L	H
VTR/1	40 x 40	40
VTR/2	80 x 40	40
VTR/3	120 x 40	40
VTR/4	160 x 40	40
VTR/5	200 x 40	40

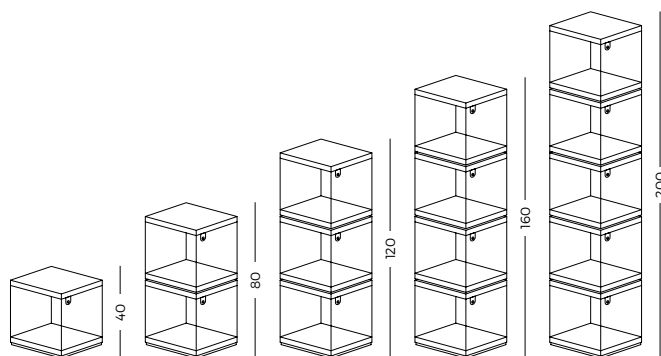

## COLOR



### VITRINAS

**ESP.** Vitrina expositora cuadrada de chapa metálica y laterales de PMMA. Vista interior de 360°. Envío de la estantería desmontada. Puerta abatiente con llave. Disponible en 5 alturas estandar y 2 colores.

### DISPLAY CASE

**ENG.** Display case made from sheet metal and PMMA sides. 360° visible interior. Folding door with key. Available in 5 standard heights and 2 colors. Easy assembly. Ships disassembled.

### VITRINE

**FRA.** Vitrine en tôle et côtés en PMMA. 360° intérieur visible. Porte pliante avec clé. Disponible en 5 hauteurs standard et 2 couleurs. Assemblage facile. Navires démontés.



# VTR

VITRINAS DE PIÉ  
VITRINA DE PIE -VITRINA DE PIE



## COLOR



/AN /BL

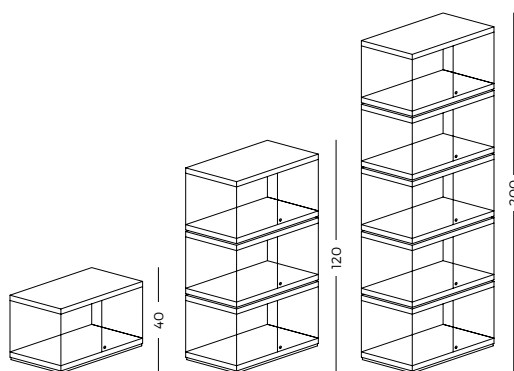

REF	L	H
<b>VTR/11</b>	40 x 80	40
<b>VTR/12</b>	80 x 80	40
<b>VTR/13</b>	120 x 80	40
<b>VTR/14</b>	160 x 80	40
<b>VTR/15</b>	200 x 80	40



## VITRINAS

**ESP.** Vitrina expositora rectangular de chapa metálica y laterales de PMMA. Vista interior de 360°. Envío de la estantería desmontada. Puerta abatiente con llave. Disponible en 5 alturas estandar y 2 colores.

## DISPLAY CASE

**ENG.** Display case made from sheet metal and PMMA sides. 360° visible interior. Folding door with key. Available in 5 standard heights and 2 colors. Easy assembly. Ships disassembled.

## VITRINE

**FRA.** Vitrine en tôle et côtés en PMMA. 360° intérieur visible. Porte pliante avec clé. Disponible en 5 hauteurs standard et 2 couleurs. Assemblage facile. Navires démontés.

# VTR

VITRINAS DE PIÉ  
VITRINA DE PIE -VITRINA DE PIE

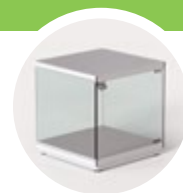

REF	DESC.	L	H
<b>VTR/40/B</b>	Base	40 x 40	40
<b>VTR/40/I</b>	Intermedio	40 x 40	40
<b>VTR/40/T</b>	Tapa	40 x 40	40
<b>VTR/80/B</b>	Base	40 x 80	40
<b>VTR/80/I</b>	Intermedio	40 x 80	40
<b>VTR/80/T</b>	Tapa	40 x 80	40
<b>VTR/40D/B</b>	Base	80 x 40	40
<b>VTR/40D/I</b>	Intermedio	80 x 40	40
<b>VTR/40D/T</b>	Tapa	80 x 40	40

**COLOR**

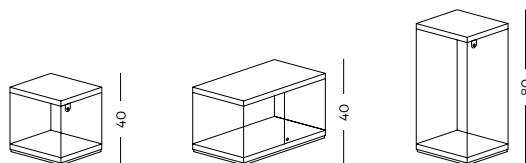

**VITRINAS**

**ESP.** Vitrina expositora cuadrada de chapa metálica y laterales de PMMA. Vista interior de 360°. Envío de la estantería desmontada. Puerta abatiente con llave. Montaje personalizado.

**DISPLAY CASE**

**ENG.** Display case made from sheet metal and PMMA sides. 360° visible interior. Folding door with key. Easy assembly. Ships disassembled. Customizable.

**VITRINE**

**FRA.** Vitrine en tôle et côtés en PMMA. 360° intérieur visible. Porte pliante avec clé. Personnalisation disponible. Assemblage facile. Navires démontés.



# VTR

VITRINAS DE PIÉ  
VITRINA DE PIE -VITRINA DE PIE



**COLOR**



REF	DESC.	L	H
VTR/L	Soporte Mural	40 x 40	40
VTR/P1	Soporte Pié	120 x 40	40
VTR/P2	Soporte Pié Doble	120 x 80	40

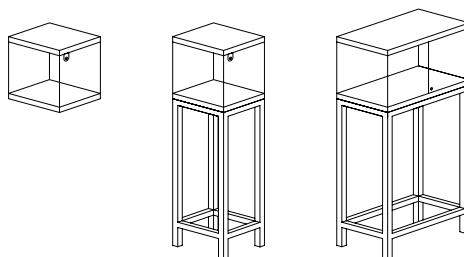

Vitrina no incorporada  
Display case not included  
Vitrine non incluse



**VITRINAS**

**ESP.** Accesorios para vitrina expositora: soporte mural en forma de L para vitrina individual. Soporte de pié para vitrinas individuales o dobles.

**DISPLAY CASE**

**ENG.** Accessories for display case: L-shaped wall mount for individual showcase. Support for individual or double showcases.

**VITRINE**

**FRA.** Accessoires pour vitrine: support murale en forme de L pour vitrine individuelle. Support de pied pour vitrines individuelles ou doubles.



# TIME

RELOJ MURAL  
WALL CLOCK - HORLOGE MURALE



REF	∅	HT
RE/AC/26	26	4
RE/AC/31	31	4
RE/AC/38	38	4

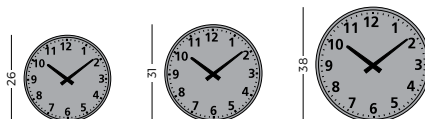

## RELOJ MURAL

**ESP.** Colección de relojes fabricados en plástico y metal de alta calidad. Disponibles en varios tamaños, colores y diferentes acabados. Ideales para oficinas, colectividades y ambientes comunes.

## WALL CLOCK

**ENG.** High quality clock range made of metal and plastic. Available in various colours, sizes and finishes. Suitable for offices and public/private places.

## HORLOGE MURALE

**FRA.** Collection d'horloges en plastique et métal de très bonne qualité. Disponibles en plusieurs couleurs, dimensions et finitions. Idéale pour le bureau, les parties communes et publiques.



# TIME

RELOJ MURAL  
WALL CLOCK - HORLOGE MURALE



REF	∅	H
RE/ME/38	38	5,5
RE/ME/60	60	5,5
RE/ME/75	75	5,5

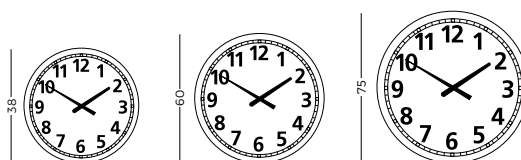

## RELOJ MURAL

**ESP.** Colección de relojes fabricados en plástico y metal de alta calidad. Disponibles en varios tamaños, colores y diferentes acabados. Ideales para oficinas, colectividades y ambientes comunes.

## WALL CLOCK

**ENG.** High quality clock range made of metal and plastic. Available in various colours, sizes and finishes. Suitable for offices and public/private places.

## HORLOGE MURALE

**FRA.** Collection d'horloges en plastique et métal de très bonne qualité. Disponibles en plusieurs couleurs, dimensions et finitions. Idéale pour le bureau, les parties communes et publiques.

# LIGHT

LÁMPARA DE SOBREMESA  
TAMBLE LAMP - LAMPE DE BUREAU



REF	L	H	LM.	LAMP.	COLORES
<b>LAS/106</b>	15,7-40 x 13,7-35	5,3-13,5	550 lm	6W LED - 4000K	/BL - /NG
<b>LAS/107</b>	49 x 16	34	250 lm	11W LED - 2700K	/BL - /NG - /GR

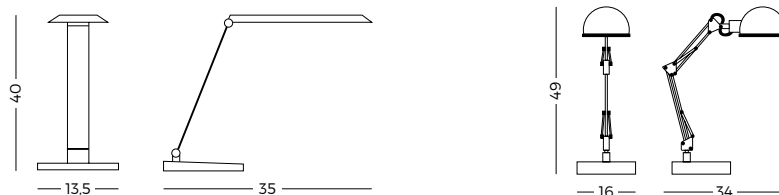

## LÁMPARA DE SOBREMESA

**ESP.** Colección de lámparas de sobremesa de diseño y de alta calidad. Distintas referencias disponibles para diferentes espacios y proyectos. Lámparas LED y bombillas de bajo consumo. Recomendable tanto para oficina y contract como para el hogar.

## DESK LAMP

**ENG.** Collection of high quality designer table lamps. Different models available depending on use. LED lamps with energy saving bulbs. Recommended for office, contract as well as home use.

## LAMPE DE BUREAU

**FRA.** Collection de lampes de table design de grande qualité. Plusieurs références disponibles pour différents espaces et projets. Lampes LED et ampoule basse consommation. Recommandées tant pour le bureau et le « contract » que pour la maison.



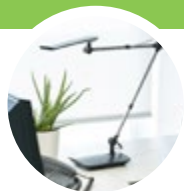
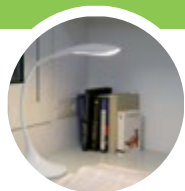

# LIGHT

LÁMPARA DE SOBREMESA  
TAMBLE LAMP - LAMPE DE BUREAU



## COLOR



/NG /BL

## REF

**LAS/105**  
**LAS/109**

L  
15,5-34 x 12,5  
59 - 20-70



10,5  
15

## LM.

800 lm  
390 lm

## LAMP.

10W LED - 4000K  
5W LED - 3000K

## COLORES

/BL - /NG  
/NG

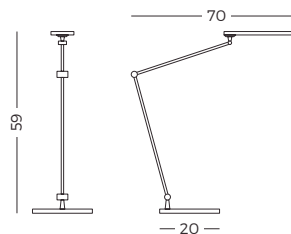
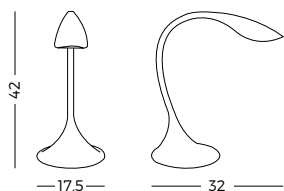

## LÁMPARA DE SOBREMESA

**ESP.** Colección de lámparas de sobremesa de diseño y de alta calidad. Distintas referencias disponibles para diferentes espacios y proyectos. Lámparas LED y bombillas de bajo consumo. Recomendable tanto para oficina y contract como para el hogar.

## DESK LAMP

**ENG.** Collection of high quality designer table lamps. Different models available depending on use. LED lamps with energy saving bulbs. Recommended for office, contract as well as home use.

## LAMPE DE BUREAU

**FRA.** Collection de lampes de table design de grande qualité. Plusieurs références disponibles pour différents espaces et projets. Lampes LED et ampoule basse consommation. Recommandées tant pour le bureau et le « contract » que pour la maison.

# **ROTULPLAN**

SISTEMAS DE ROTULACIÓN  
SIGN SYSTEMS  
SYSTÈMES DE SIGNALÉTIQUE



Locker Rooms



Toilets



Gymnasium

Fitness Center

2nd Floor

# 788

PICTOGRAMAS  
PICTOGRAM - PICTOGRAMME

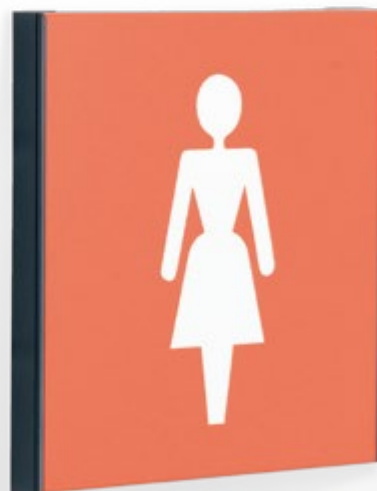

REF	DESC.
788/M	Mural
788/P	Pictograma

COLOR

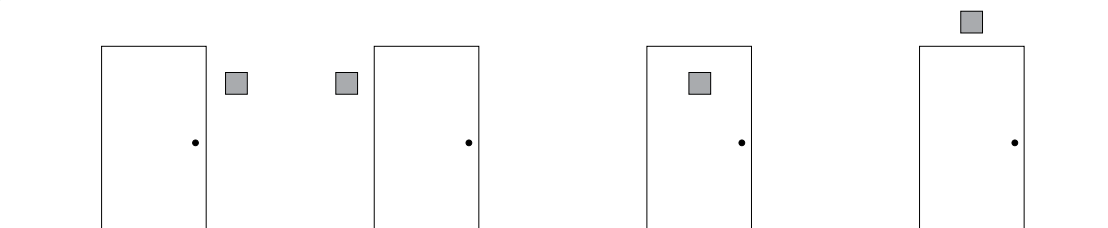
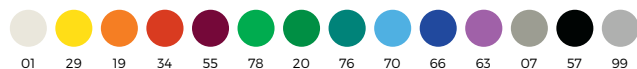

**PICTOGRAMAS**

**ESP.** Pictograma mural con silueta de vinilo en color blanco o negro, fabricado con perfil de aluminio lacado disponible en 14 colores standard y 4 tamaños distintos 12 x 12, 16 x 16, 12 x 24 y 16 x 32 cm. Las fijaciones laterales son metálicas pintadas en negro.

**PICTOGRAM**

**ENG.** Aluminium wall pictogram with white or black pictures and 14 different colour backdrops. Available in 4 sizes 12 x 12, 16 x 16, 12 x 24 and 16 x 32 cm. End caps are painted in black. Fixed to the wall through screws and optionally through double face adhesive.

**PICTOGRAMME**

**FRA.** Pictogramme mural sur profil en aluminium laqué avec marquage en vinyle blanc ou noir. Disponible en 4 formats 12 x 12, 16 x 16, 12 x 24 et 16 x 32 cm. et plaques en 14 couleurs standard. Les fixations latérales sont métalliques coloris noir. Option adhesif.



### RÓTULO MURAL

REF	L	H
<b>788/M/12</b>	12 x 12	0,9
<b>788/M/16</b>	16 x 16	0,9
<b>788/M/24</b>	12 x 24	0,9
<b>788/M/32</b>	16 x 32	0,9



### RÓTULO MURAL

REF	L	H
<b>788/P/12</b>	12 x 12	0,9
<b>788/P/16</b>	16 x 16	0,9
<b>788/P/24</b>	12 x 24	0,9
<b>788/P/32</b>	16 x 32	0,9

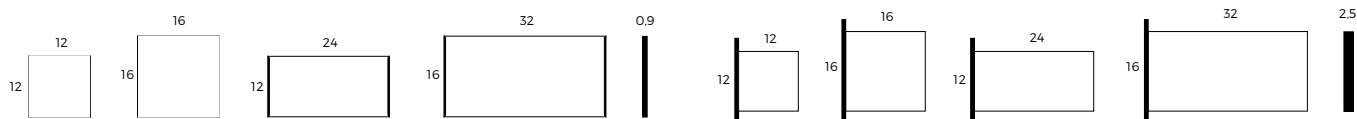

### PICTOGRAMAS



- 1. Aseos caballeros - Men toilet
- 2. Aseos señora - Women toilet
- 3. Aseos - Toilets-restroom
- 4. Restaurante - Restaurant
- 5. Cafetería - Coffee shop
- 6. Teléfono - Téléphone
- 7. Información - Information
- 8. Guardarropa - Cloakroom
- 9. No pasar - Do not cross

- 10. No fumar - No smoking
- 11. Flecha - Arrow
- 13. Ascensor - Lift
- 14. Diversidad funcional - Functional diversity
- 15. Sala de reuniones - Mtg. room
- 16. Subida escaleras - Up stairs
- 18. Bajada escaleras - Down stairs
- 20. Sala espera - Waiting room

- 21. Salida - Way out
- 22. Entrada - Way in
- 24. Limpieza - Cleaning room
- 25. Correos - Post office
- 36. Ducha - Shower
- 37. Piscina - Swimming pool
- 39. Vest. masc. - Men room
- 40. Vest. fem. - Women change room

- 41. Peluquería - Hairdresser
- 42. Oficina - Office
- 44. Consigna - Lockers
- 45. Recepción - Reception
- 47. Sala TV - TV room
- 48. Servicios médicos - Medical facilities
- 49. Hospital - Hospital
- 50. Silencio - Silence

- 51. Pto. de encuentro - Mtg. point
- 52. Biblioteca - Library
- 54. Escaleras - Escalator
- 60. Fumadores - Smoking room
- 61. Animales no - No animals entry
- 64. Enfermería - Infirmary
- 69. Basuras no - Rubbish bin
- 74. Fotos no - No cameras
- 164. Móviles no - No mobile phones

# 789/M

RÓTULOS MURALES  
WALL SIGNS - SIGNALÉTIQUE MURALE

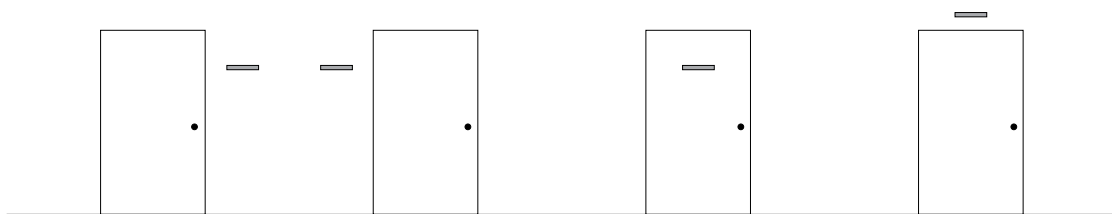
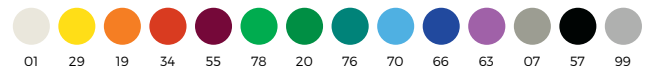
**COLOR**

**RÓTULOS MURALES**

**ESP.** Rótulo mural margen puerta de aluminio lacado, de texto fijo en vinilo de color blanco o negro. Disponible en 5 medidas de altura, 4, 8, 12 y 16 cm. y 14 colores standard. Se aplican sobre la pared mediante tornillos u opcionalmente con adhesivo doble cara.

**WALL SIGNS**

**ENG.** Aluminium wall signs for door frames with white or black letters and 14 different coloured backdrops. Available in 5 distinct sizes with heights of 4, 8, 12 and 16 cm. respectively. Mount any wall sign with screws or adhesives.

**SIGNALÉTIQUE MURALE**

**FRA.** Signalétique murale sur profil en aluminium laqué avec marquage en vinyle blanc ou noir. Disponible en 5 formats 4, 8, 12, et 16 cm. de haut et 14 coloris standard. Fixation par vis sous la plaque ou optionnellement par adhésif double face.



# Información

## Planta

### RÓTULOS - 4 CM

REF	L	TEXT	ABC
789/4/12/M	4 x 12	2	8/10
789/4/24/M	4 x 24	2	12/14
789/4/32/M	4 x 32	2	18/20
789/4/48/M	4 x 48	2	24/26
789/4/64/M	4 x 64	2	28/30



### RÓTULOS - 6 CM - 8 CM

REF	L	TEXT	ABC
789/6/24/M	6 x 24	2,6	8/10
789/6/32/M	6 x 32	2,6	12/14
789/6/48/M	6 x 48	2,6	18/20
789/6/64/M	6 x 64	2,6	24/26
789/8/24/M	8 x 24	3,2	8/10
789/8/32/M	8 x 32	3,2	12/14
789/8/48/M	8 x 48	3,2	18/20
789/8/64/M	8 x 64	3,2	24/26



### RÓTULOS - 12 CM - 16 CM

REF	L	TEXT	ABC
789/12/32/M	12 x 32	4,8	8/10
789/12/48/M	12 x 48	4,8	12/14
789/12/64/M	12 x 64	4,8	18/20
789/12/96/M	12 x 96	4,8	24/26
789/16/24/M	16 x 32	6,4	6/8
789/16/32/M	16 x 48	6,4	8/10
789/16/48/M	16 x 64	6,4	12/14
789/16/64/M	16 x 96	6,4	18/20



### TEXTOS - 2ª LINEA

REF	L
TA/24	24
TA/32	32
TA/48	48
TA/64	64
TA/96	96

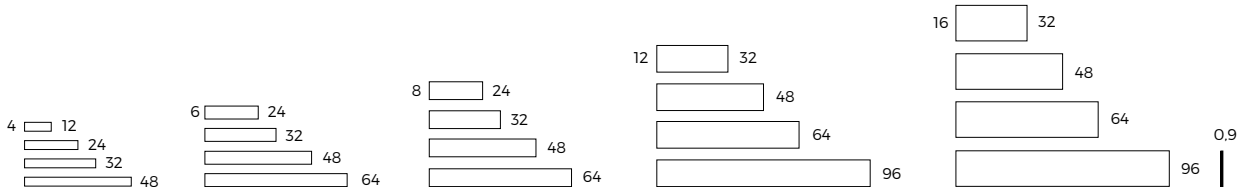

### PICTOGRAMAS

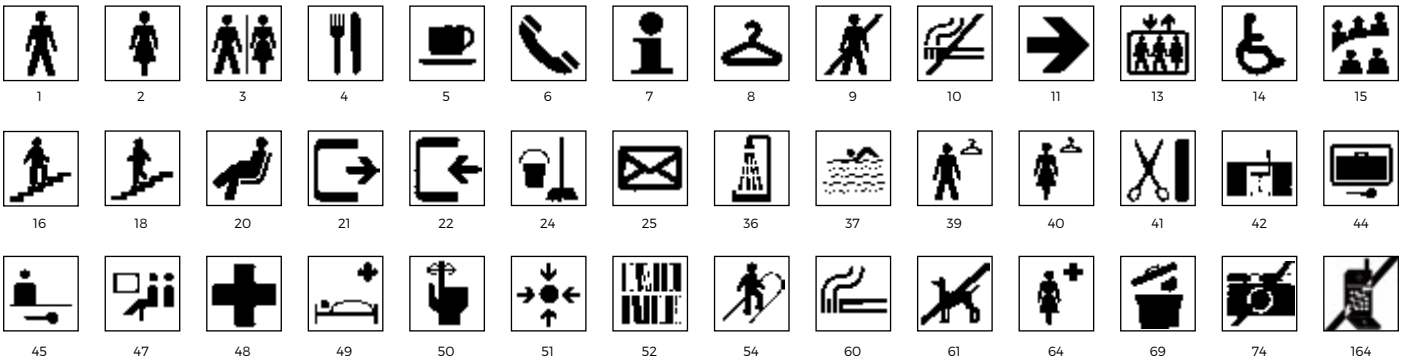

- 1. Aseos caballeros - Men toilet
- 2. Aseos señora - Women toilet
- 3. Aseos - Toilets-restroom
- 4. Restaurante - Restaurant
- 5. Cafetería - Coffee shop
- 6. Teléfono - Téléphone
- 7. Información - Information
- 8. Guardarropa - Cloakroom
- 9. No pasar - Do not cross

- 10. No fumar - No smoking
- 11. Flecha - Arrow
- 13. Ascensor - Lift
- 14. Diversidad funcional - Functional diversity
- 15. Sala de reuniones - Mtg. room
- 16. Subida escaleras - Up stairs
- 18. Bajada escaleras - Down stairs
- 20. Sala espera - Waiting room

- 21. Salida - Way out
- 22. Entrada - Way in
- 24. Limpieza - Cleaning room
- 25. Correos - Post office
- 36. Ducha - Shower
- 37. Piscina - Swimming pool
- 39. Vest. masc. - Men room
- 40. Vest. fem. - Women change room

- 41. Peluquería - Hairdresser
- 42. Oficina - Office
- 44. Consigna - Lockers
- 45. Recepción - Reception
- 47. Sala TV - TV room
- 48. Servicios médicos - Medical facilities
- 49. Hospital - Hospital
- 50. Silencio - Silence

- 51. Pto. de encuentro - Mtg. point
- 52. Biblioteca - Library
- 54. Escaleras - Escalator
- 60. Fumadores - Smocking room
- 61. Animales no - No animals entry
- 64. Enfermería - Infirmary
- 69. Basuras no - Rubbish bin
- 74. Fotos no - No cameras
- 164. Móviles no - No mobile phones

# 789/P

RÓTULO PROYECTADO  
FLAG SIGNS - SIGNALÉTIQUE EN DRAPEAU



COLOR

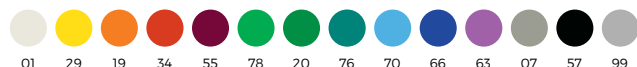

RÓTULO MURAL

REF	L	H
789/8/24/P	8 x 24	2,5
789/8/32/P	8 x 32	2,5
789/8/48/P	8 x 48	2,5
789/12/24/P	12 x 24	2,5
789/12/32/P	12 x 32	2,5
789/12/48/P	12 x 48	2,5
789/16/24/P	16 x 24	2,5
789/16/32/P	16 x 32	2,5
789/16/48/P	16 x 48	2,5

SUBRAYADO

REF	L	H
LS/2/24/P	2 x 24	2,5
LS/2/32/P	2 x 32	2,5
LS/2/48/P	2 x 48	2,5

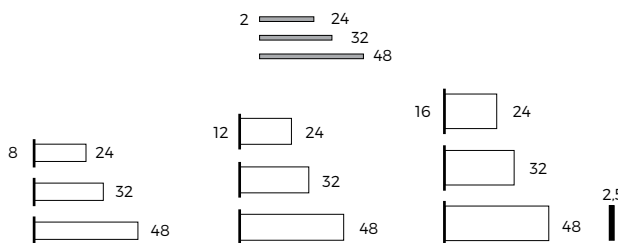

RÓTULO PROYECTADO

**ESP.** Rótulo proyectado doble cara de aluminio lacado, de texto fijo en vinilo de color blanco o negro. Disponible en 3 medidas de altura, 8, 12 y 16 cm. y de longitud 24, 32 y 48 cm. Se aplican sobre la pared mediante tornillos.

FLAG SIGNS

**ENG.** Aluminium double sided flag wall signs with white or black letters. Available in 3 distinct sizes with heights of 8, 12 and 16 cm. and lengths of 24, 32 and 48 cm. respectively. Mount any projected wall sign with screws.

SIGNALÉTIQUE EN DRAPEAU

**FRA.** Signalétique en drapeau sur profil en aluminium laqué avec marquage en vinyle blanc ou noir. Disponible en 3 formats 8, 12 et 16 cm. de haut. et 24, 32 et 48 cm. de longueur. Fixation par vis sur la plaque.





# 789/S

RÓTULO SUSPENDIDO  
SUSPENDED SIGNS - SIGNALÉTIQUE SUSPENDUE

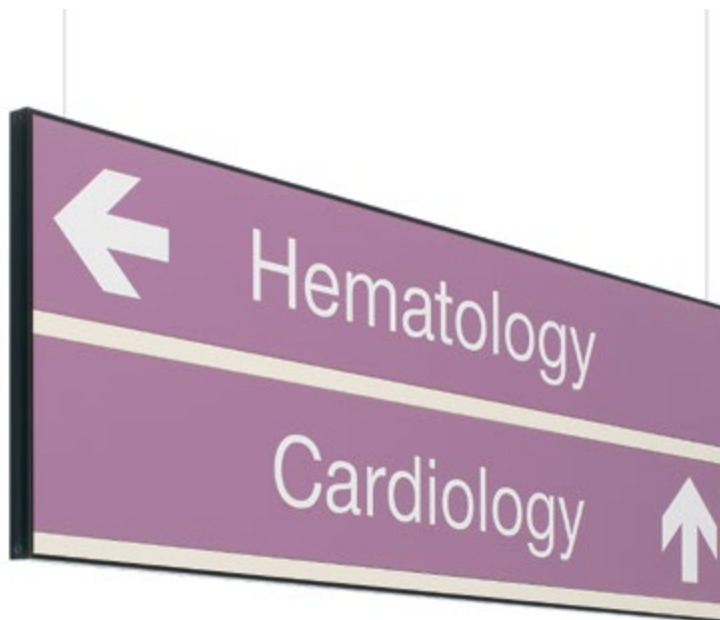

**COLOR**

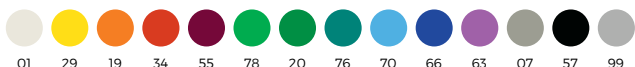

**SUBRAYADO**

REF	L	H
LS/2/24/P	2 x 24	2,5
LS/2/32/P	2 x 32	2,5
LS/2/48/P	2 x 48	2,5

**RÓTULO SUSPENDIDO**

REF	L	H
789/8/48/S	8 x 48	2,5
789/8/64/S	8 x 64	2,5
789/8/96/S	8 x 96	2,5
789/12/48/S	12 x 48	2,5
789/12/64/S	12 x 64	2,5
789/12/96/S	12 x 96	2,5
789/16/48/S	16 x 48	2,5
789/16/64/S	16 x 64	2,5
789/16/96/S	16 x 96	2,5

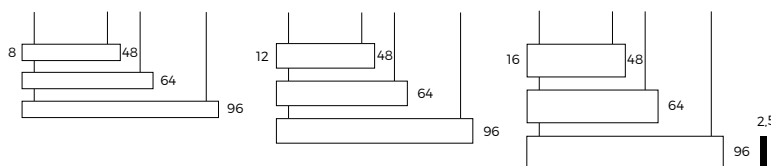

**RÓTULO SUSPENDIDO**

**ESP.** Rótulo suspendido doble cara de aluminio lacado, de texto fijo en vinilo de color blanco o negro. Disponible en 3 medidas de altura, 8, 12 y 16 cm. Se suspenden del techo mediante cable de metal (incluido). Estas señales se colocan en pasillos y accesos.

**SUSPENDED SIGNS**

**ENG.** Aluminium suspended signs with white or black letters and 14 different colored backdrops. Available in 3 distinct sizes with heights of 8, 12 and 16 cm. Suspend sign with included metallic string.

**SIGNALÉTIQUE SUSPENDU**

**FRA.** Signalétique suspendue sur profil en aluminium laqué avec marquage en vinyle blanc ou noir. Disponible en 3 formats 8, 12, et 16 cm. de hauteur. Suspendus au plafond par un câble de métallique (inclus).

# 790/D

DIRECTORIO MURAL  
DIRECTIONAL SIGNS - MULTI-PLAQUES



**COLOR**

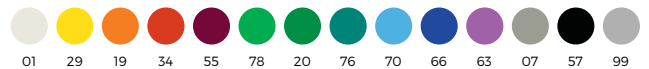

2	
Marketing	
Administration	
1	
R+d	
Laboratory	
0	
Reception	

GANT HOTEL	
1. Information	→
2. Rooms	↑
3. Pool	←
4. Gymnasium	↓
1	2
3	4

High School	
Classroom 1-10	→
Classroom 11-20	→
Classroom 21-30	↑
Classroom 31-40	↑
Information	→
Gymnasium	←
Toilets	↑

SPORT	
Gymnasium	→
Cafeteria	→
Natatorium	↑
Toilets	↑
Fitness Center	→
Tennis Courts	←

3	UCI
	Administration
2	Oncology
	Endoscopy
1	Medical Imaging
	Volunter Service
0	Main Entrance
	Administration
	Waiting Room

**DIRECTORIOS MURALES**

**ESP.** Directorio formado por laminas de aluminio lacado, de texto fijo en vinilo de color blanco o negro. Disponible en 7 medidas de altura, 1, 2, 4, 6, 8, 12 y 16 cm. Disponible en 14 colores.

**DIRECTIONAL SIGNS**

**ENG.** Lacquered aluminium mini directories with white or black letters and 14 different colour backdrops. Available in 7 distinct sizes with heights of 1, 2, 4, 6, 8, 12 and 16 cm.

**MULTI-PLAQUES**

**FRA.** Directoire multi plaques sur profil en aluminium laqué avec lettres blanches ou noires et 14 coloris standard. Disponible en 7 formats 1, 2, 4, 6, 8, 12 et 16 cm. de haut.

# PLANTA 2

 Información 

## RÓTULOS - 2 CM - 4 CM

REF	L	TEXT	ABC
790/2/24/D	2 x 24	-	-
790/2/32/D	2 x 32	-	-
790/2/48/D	2 x 48	-	-
790/2/64/D	2 x 64	-	-
790/2/96/D	2 x 96	-	-
790/4/24/D	4 x 24	2	12/20
790/4/32/D	4 x 32	2	18/24
790/4/48/D	4 x 48	2	24/26
790/4/64/D	4 x 64	2	36/38
790/4/96/D	4 x 96	2	60/62



## RÓTULOS - 6 CM - 8 CM

REF	L	TEXT	ABC
790/6/24/D	6 x 24	2	10/18
790/6/32/D	6 x 32	2	14/16
790/6/48/D	6 x 48	2	20/24
790/6/64/D	6 x 64	2	30/36
790/6/96/D	6 x 96	2	40/48
790/8/24/D	8 x 24	3,2	8/10
790/8/32/D	8 x 32	3,2	12/14
790/8/48/D	8 x 48	3,2	16/18
790/8/64/D	8 x 64	3,2	24/26
790/8/96/D	8 x 96	3,2	36/38



## RÓTULOS - 12 CM - 16 CM

REF	L	TEXT	ABC
790/12/24/D	12 x 24	4,8	6/8
790/12/32/D	12 x 32	4,8	8/10
790/12/48/D	12 x 48	4,8	12/14
790/12/64/D	12 x 64	4,8	18/20
790/12/96/D	12 x 96	4,8	24/26
790/16/24/D	16 x 24	6,4	4/6
790/16/32/D	16 x 32	6,4	6/8
790/16/48/D	16 x 48	6,4	8/10
790/16/64/D	16 x 64	6,4	12/24
790/16/96/D	16 x 96	6,4	18/20

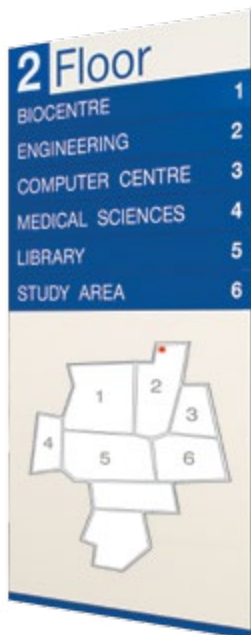
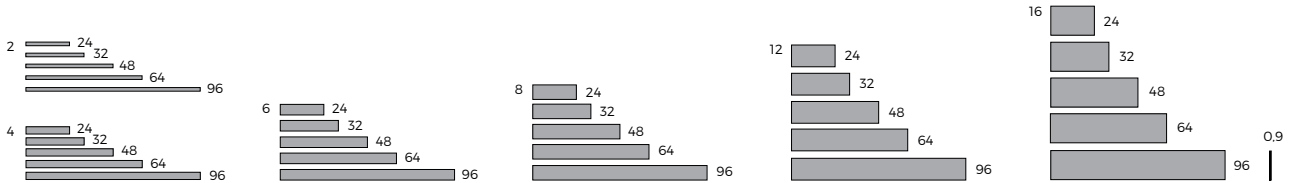

## PLANOS

REF	L	TEXT
790/PD/24	24 x 24	0,9
790/PD/32	32 x 32	0,9
790/PD/48	48 x 48	0,9
790/PD/64	64 x 64	0,9
790/PD/96	96 x 96	0,9



## TEXTOS - 2ª LINEA

REF	L
TA/24	24
TA/32	32
TA/48	48
TA/64	64
TA/96	96

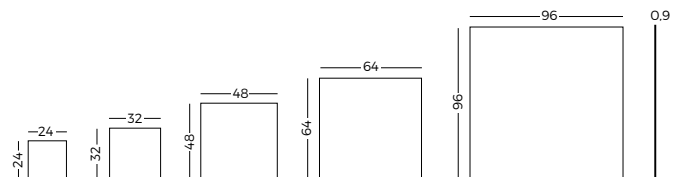

# 793/M

RÓTULO CURVO  
CURVED SIGNS - SIGNALÉTIQUE EN COURBÉ



Los rótulos se suministran sin papel.  
Signs supplied without paper.  
Signalétique sans papier.

REF	L	H	?
<b>793/M/12</b>	12 x 12	1	11,5 x 12
<b>793/M/15</b>	15 x 15	1,2	14,5 x 15
<b>793/M/21</b>	21 x 21	1,4	20,5 x 21
<b>793/M/30</b>	30 x 30	1,8	29,5 x 30
<b>793/M/40</b>	40 x 40	2	39,5 x 40

REF	L	H	?
<b>793/M/50</b>	50 x 50	2,5	49,5 x 50
<b>793/M/60</b>	60 x 60	3	59,5 x 60
<b>793/M/A5</b>	21 x 15	1,2	20,5 x 15
<b>793/M/A4</b>	29,7 x 21	1,4	29,2 x 21
<b>793/M/A3</b>	42 x 29,7	1,8	41,5 x 29,7

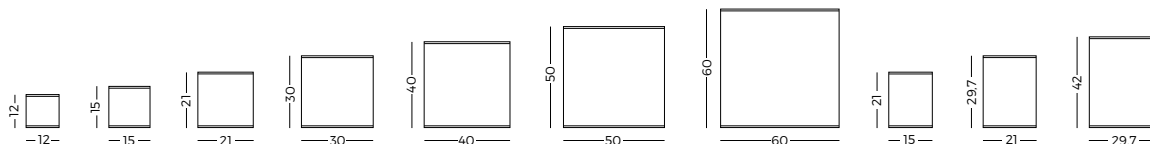

## PICTOGRAMA Y DIRECTORIO CURVO

**ESP.** Rótulos de perfil curvo para pictogramas murales. Está fabricado con perfil de aluminio anodinado en color plata mate. El soporte permite la incorporación del papel pictograma o texto). Mediante una ventosa especial se puede levantar el plástico protector.

## CURVED PICTOGRAMS AND DIRECTORY

**ENG.** Curved profile wall pictos made with silver anodized aluminium frame. The transparent sleeve allows you to add paper with pictograms or text. With suction cup pull off transparent sleeve to change text. Place on the wall with screws or optionally adhesive.

## PICTOGRAMMES ET PLAQUES COURBÉ

**FRA.** Profil mural en aluminium anodisé convexe pour signalétique ou pictogrammes. L'incorporation de l'information papier (pictogramme ou texte) est facile. Grâce à une ventouse on enlève le plastique transparent qui protège le support et on insère le texte.



# 793/P

PICTOGRAMA PROYECTADO CURVO

CURVED DOUBLE SIDED FLAG PICTOGRAM - PICTOGRAMME EN DRAPEAU COURBÉ



Los rótulos se suministran sin papel.  
Signs supplied without paper.  
Signalétique sans papier.

REF	L	H	?
<b>793/P/15</b>	15 x 15	2,4	14,5 x 15
<b>793/P/21</b>	21 x 21	2,8	20,5 x 21
<b>793/P/30</b>	30 x 30	3,6	29,5 x 30

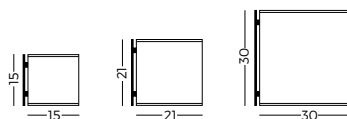

## PICTOGRAMA PROYECTADO CURVO

**ESP.** Rótulo de perfil curvo para pictogramas proyectados (doble cara). Está fabricado con perfil de aluminio anodizado en color plata mate. El soporte permite la incorporación del papel (pictograma o texto). Mediante una ventosa se puede levantar el plástico protector.

## CURVED FLAG PICTOGRAM

**ENG.** Curved profile double sided flag pictos with for wall pictograms made with silver anodized aluminium frame. The support allows you to add paper with pictograms or text. With suction cup pull off transparent sleeve. Place on the wall with screws.

## PICTOGRAMME EN DRAPEAU COURBÉ

**FRA.** Profil mural en aluminium anodisé convexe pour signalétique ou pictogrammes. L'incorporation de l'information papier (picto ou texte) est facile. Grâce à une ventouse on enlève le plastique transparent qui protège le support et on insère le texte.

# 799/M

RÓTULO MURAL CURVO  
CURVED PROFILE SIGN - SIGNALÉTIQUE COURBE



Los rótulos se suministran sin papel.  
Signs supplied without paper.  
Signalétique sans papier.

REF	DESC.
799/M	Mural
799/P	Pictograma

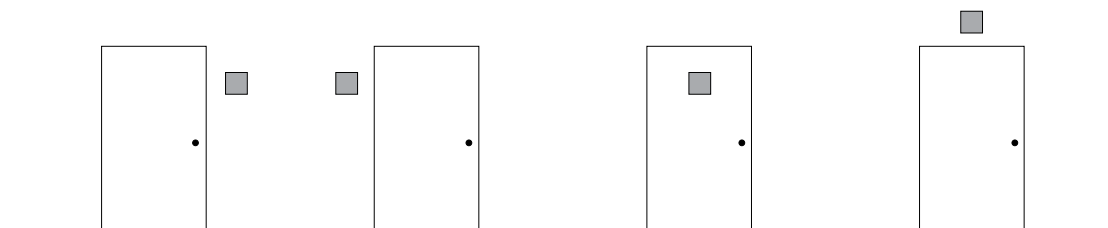

## RÓTULO MURAL PERFIL CURVO

**ESP.** Rótulo mural de perfil curvo. Está fabricado con perfil de aluminio anodizado en color plata mate. El soporte permite la incorporación del papel (pictograma o texto). Mediante una ventosa especial se puede levantar frontalmente el plástico transparente que lo protege.

## CURVED PROFILE SIGN

**ENG.** Wall curved profile sign made with silver anodized aluminium frame. The transparent sleeve allows you to add paper with pictograms or text. With a suction cup pull off the transparent sleeve to change the text. Placed on the wall with screws or with adhesive.

## SIGNALÉTIQUE PROFIL COURBE

**FRA.** Profil mural en aluminium anodisé convexe pour signalétique ou pictogrammes. L'incorporation de l'information papier (picto ou texte) est facile. Grâce à une ventouse on enlève le plastique transparent qui protège le support et on insère le texte. Option adhesifs.



### RÓTULOS MURAL

REF	L	H
799/4/12/M	4 x 12	0,8
799/4/24/M	4 x 24	0,8
799/4/32/M	4 x 32	0,8
799/4/48/M	4 x 48	0,8
799/4/64/M	4 x 64	0,8
799/6/12/M	6 x 12	0,8
799/6/24/M	6 x 24	0,8
799/6/32/M	6 x 32	0,8
799/6/48/M	6 x 48	0,8
799/6/64/M	6 x 64	0,8
799/8/12/M	8 x 12	1
799/8/24/M	8 x 24	1
799/8/32/M	8 x 32	1
799/8/48/M	8 x 48	1
799/8/64/M	8 x 64	1
799/12/24/M	12 x 24	1
799/12/32/M	12 x 32	1
799/12/48/M	12 x 48	1
799/12/64/M	12 x 64	1
799/12/72/M	12 x 72	1
799/15/24/M	15 x 24	1,2
799/15/32/M	15 x 32	1,2
799/15/48/M	15 x 48	1,2
799/15/64/M	15 x 64	1,2
799/15/72/M	15 x 72	1,2

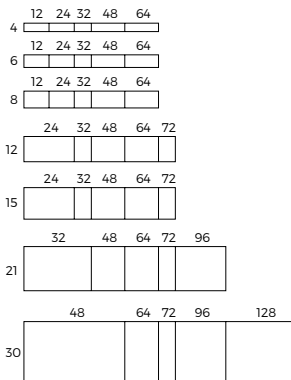

### RÓTULOS - 6 CM - 8 CM

REF	L	H
799/21/32/M	21 x 32	1,4
799/21/48/M	21 x 48	1,4
799/21/64/M	21 x 64	1,4
799/21/72/M	21 x 72	1,4
799/21/96/M	21 x 96	1,4
799/30/48/M	30 x 48	1,8
799/30/64/M	30 x 64	1,8
799/30/72/M	30 x 72	1,8
799/30/96/M	30 x 96	1,8
799/30/128/M	30 x 128	1,8
799/40/64/M	40 x 64	2
799/40/72/M	40 x 72	2
799/40/96/M	40 x 96	2
799/40/128/M	40 x 128	2
799/50/64/M	50 x 64	2
799/50/72/M	50 x 72	2
799/50/96/M	50 x 96	2
799/50/128/M	50 x 128	2
799/60/72/M	60 x 72	2
799/60/96/M	60 x 96	2
799/60/128/M	60 x 128	2
799/60/144/M	60 x 144	2

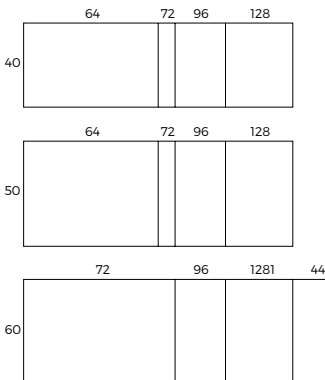

### RÓTULOS - 6 CM - 8 CM

REF	L	H
799/15/24/P	15 x 24	2,4
799/15/32/P	15 x 32	2,4
799/15/48/P	15 x 48	2,4
799/30/32/P	30 x 32	3,6
799/30/48/P	30 x 48	3,6

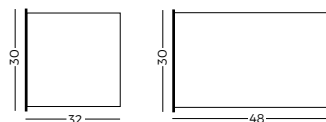
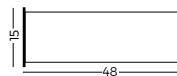
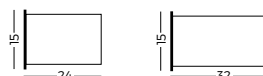

# 799/S

RÓTULO SUSPENDIDO CURVO  
 SUSPENDED CURVED SIGNS - SIGNALÉTIQUE SUSPENDUÊ COURBÉ

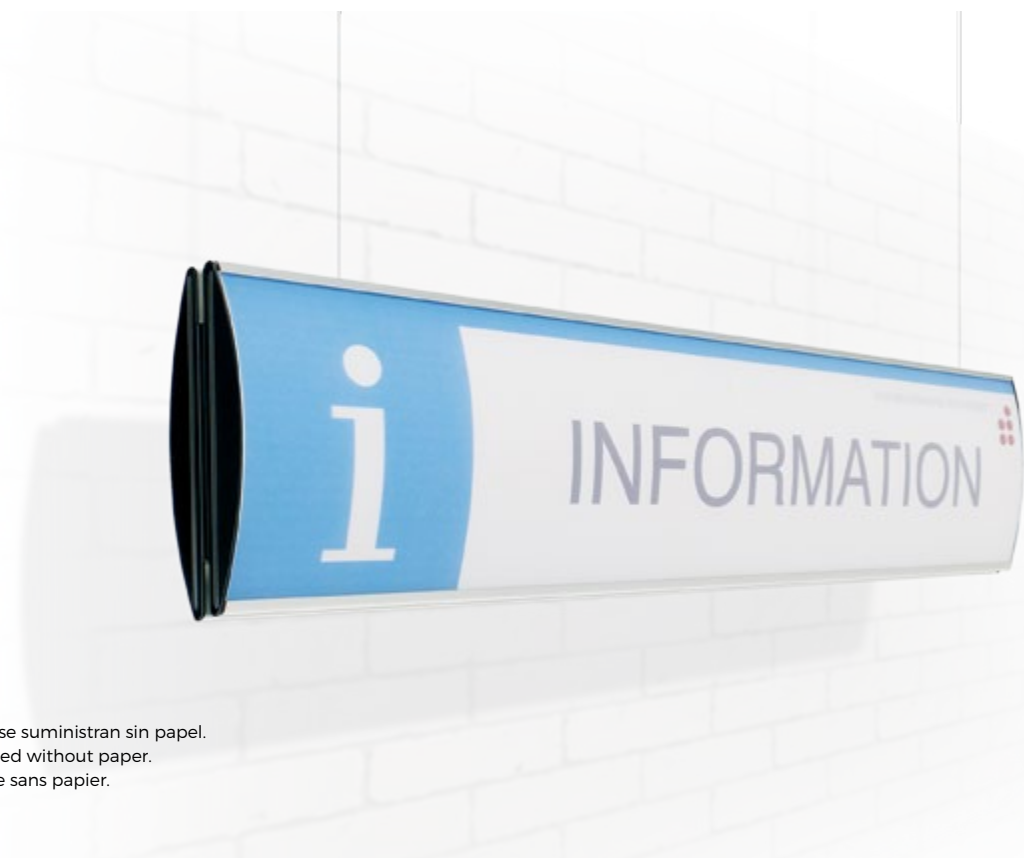

Los rótulos se suministran sin papel.  
 Signs supplied without paper.  
 Signalétique sans papier.

REF	L	H
<b>799/8/48/S</b>	8 x 48	2
<b>799/8/64/S</b>	8 x 64	2
<b>799/8/96/S</b>	8 x 96	2
<b>799/12/48/S</b>	12 x 48	2
<b>799/12/64/S</b>	12 x 64	2
<b>799/12/96/S</b>	12 x 96	2
<b>799/15/48/S</b>	15 x 48	2,4
<b>799/15/64/S</b>	15 x 64	2,4
<b>799/15/96/S</b>	15 x 96	2,4

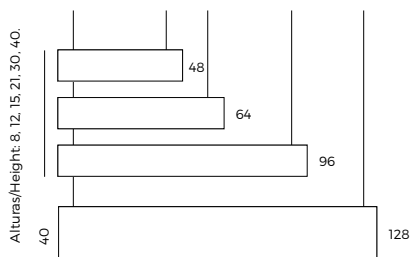

REF	L	H
<b>799/21/48/S</b>	21 x 48	2,8
<b>799/21/64/S</b>	21 x 64	2,8
<b>799/21/96/S</b>	21 x 96	2,8
<b>799/30/48/S</b>	30 x 48	3,6
<b>799/30/64/S</b>	30 x 64	3,6
<b>799/30/96/S</b>	30 x 96	3,6
<b>799/40/64/S</b>	40 x 64	4
<b>799/40/96/S</b>	40 x 96	4
<b>799/40/128/S</b>	40 x 128	4



## PICTOGRAMA Y DIRECTORIO CURVO

**ESP.** Rótulo suspendido doble cara de perfil curvo. Está fabricado con perfil de aluminio anodizado en color plata mate. El soporte permite la incorporación del papel (pictograma o texto). Mediante una ventosa especial se puede levantar el plástico protector.

## SUSPENDED CURVED PROFILE SIGNS

**ENG.** Wall curved profile double side signs made with silver anodized aluminium frame. The transparent sleeve allows you to add paper with pictograms or text. With a suction cup pull off the transparent sleeve to change the text.

## SIGNALÉTIQUE SUSPENDU COURBÉ

**FRA.** Profil suspendu double face en aluminium anodisé convexe pour signalétique ou pictogrammes. L'incorporation de l'information papier (picto ou texte) est facile. Grâce à une ventouse on enlève le plastique transparent qui protège le support et on insère le texte.







# 799/SB

RÓTULO SOBREMESA CURVO  
DESK CURVED SIGNS - SIGNALÉTIQUE À POSER COURBÉ



Los rótulos se suministran sin papel.  
Signs supplied without paper.  
Signalétique sans papier.

REF	L	H
<b>799/6/24/SB</b>	6 x 24	0,8
<b>799/6/32/SB</b>	6 x 32	0,8
<b>799/8/24/SB</b>	8 x 24	1
<b>799/8/32/SB</b>	8 x 32	1
<b>799/12/12/SB</b>	12 x 12	1

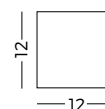
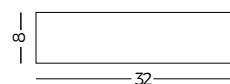
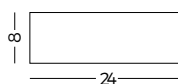
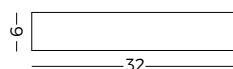
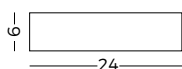

## RÓTULO SOBREMESA PERFIL CURVO

**ESP.** Rótulo de sobremesa perfil curvo. Está fabricado con perfil de aluminio anodizado en color plata mate. El soporte permite la incorporación del papel (pictograma o texto) Mediante una ventosa especial se puede levantar el plástico protector.

## DESK CURVED PROFILE SIGNS

**ENG.** Signs with curved profile desks wall are made with silver anodized aluminium frame. The transparent sleeve allows you to add paper with pictograms or text. With a suction cup pull off the transparent sleeve to change the text.

## SIGNALÉTIQUE À POSER PROFIL COURBÉ

**FRA.** Signalétique à poser, en aluminium anodisé convexe pour signalétique ou pictogrammes. L'incorporation de l'information papier (picto ou texte) est facile. Grâce à une ventouse on enlève le plastique transparent qui protège le support et on insère le texte.

# 799/M

DIRECTORIO PERFIL CURVO  
CURVED PROFILE DIRECTORIES - MULTI-PLAQUES PROFIL COURBÉ



Los rótulos se suministran sin papel.  
Signs supplied without paper.  
Signalétique sans papier.

REF	L	H
799/4/12/M	4 x 12	0,8
799/4/24/M	4 x 24	0,8
799/4/32/M	4 x 32	0,8
799/4/48/M	4 x 48	0,8
799/4/64/M	4 x 64	0,8
799/6/12/M	6 x 12	0,8
799/6/24/M	6 x 24	0,8
799/6/32/M	6 x 32	0,8
799/6/48/M	6 x 48	0,8
799/6/64/M	6 x 64	0,8

REF	L	H
799/8/12/M	8 x 12	1
799/8/24/M	8 x 24	1
799/8/32/M	8 x 32	1
799/8/48/M	8 x 48	1
799/8/64/M	8 x 64	1
799/8/96/M	8 x 96	1

REF	L	H
799/12/24/M	12 x 24	1
799/12/32/M	12 x 32	1
799/12/48/M	12 x 48	1
799/12/64/M	12 x 64	1
799/12/72/M	12 x 72	1
799/15/24/M	15 x 24	1,2
799/15/32/M	15 x 32	1,2
799/15/48/M	15 x 48	1,2
799/15/64/M	15 x 64	1,2
799/15/72/M	15 x 72	1,2

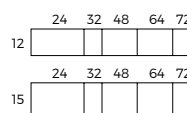
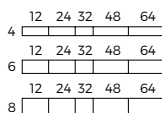

## DIRECTORIOS PERFIL CURVO

**ESP.** Rótulo mural de perfil curvo. Está fabricado con perfil de aluminio anodizado en color plata mate. El soporte permite la incorporación del papel (pictograma o texto). Mediante una ventosa especial se puede levantar frontalmente el plástico transparente que lo protege.

## CURVED PROFILE DIRECTORIES

**ENG.** Wall curved profile sign made with silver anodized aluminium frame. The transparent sleeve allows you to add paper with pictograms or text. With a suction cup pull off the transparent sleeve to change the text. Placed on the wall with screws or with adhesive.

## MULTI-PLAQUES PROFIL COURBÉ

**FRA.** Profil mural en aluminium anodisé convexe pour signalétique ou pictogrammes. L'incorporation de l'information papier (pictogramme ou texte) est facile. Grâce à une ventouse on enlève le plastique transparent qui protège le support et on insère le texte.



# 799/T

TOTEM PERFIL CURVO  
CURVED PROFILE TOTEM - TOTEM PROFIL COURBÉ



Los rótulos se suministran sin papel.  
Signs supplied without paper.  
Signalétique sans papier.

REF	L
799/T2/180	180 x 60
799/T2/200	200 x 60

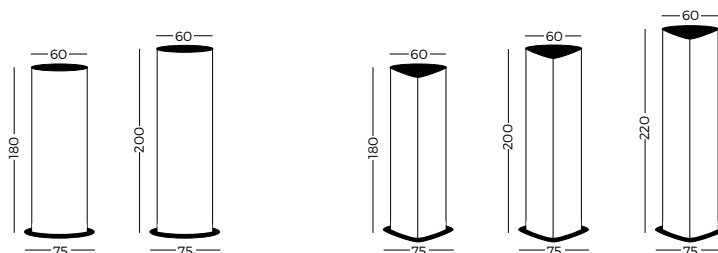

REF	L
799/T3/180	180 x 60
799/T3/200	200 x 60
799/T3/220	220 x 60



## TOTEM PERFIL CURVO

**ESP.** Totems verticales doble o triple cara de perfil curvo. Están fabricados con perfil de aluminio anodizado en color plata mate. El soporte permite la incorporación del documento mediante una ventosa especial para levantar el plástico transparente que lo protege.

## CURVED PROFILE TOTEM

**ENG.** Totem double or triple side made of anodized aluminium, which allow to switch texts and pictograms with a suction cup to pull off the transparent sleeve to change the information.

## TOTEM PROFIL COURBÉ

**FRA.** Totems sur profil courbe en aluminium anodisé double et triple face. Le support permet l'incorporation de papier (pictos ou texte) grâce à une ventouse on enlève le plastique transparent qui protège le support et ainsi changer l'information.

# GR/M

PICTOGRAMAS Y DIRECTORIOS "GRIP"  
WALL SIGN "GRIP" - SIGNALÉTIQUE MURALE "GRIP"

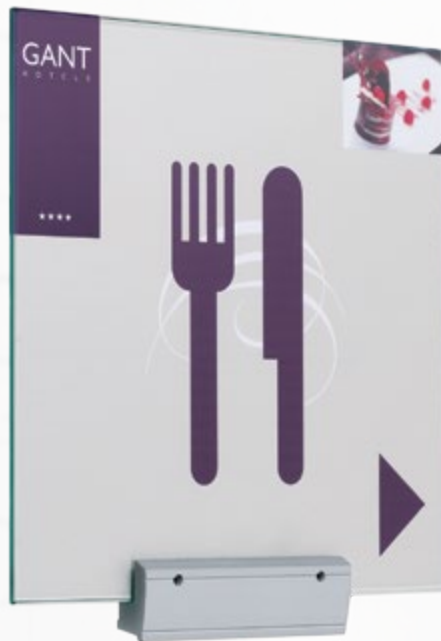

REF	DESC.	L	H
GR/12/M	Panel	12 x 12	1,6
GR/16/M	Panel	16 x 16	1,6
GR/21/M	Panel	21 x 21	1,6
GR/A4/M	Panel	30 x 21	1,6
GR/A3/M	Panel	42 x 30	1,6
GR/A2/M	Panel	60 x 42	1,6
GR/10	Soporte	4 x 10	1,6
GR/20	Soporte	4 x 20	1,6

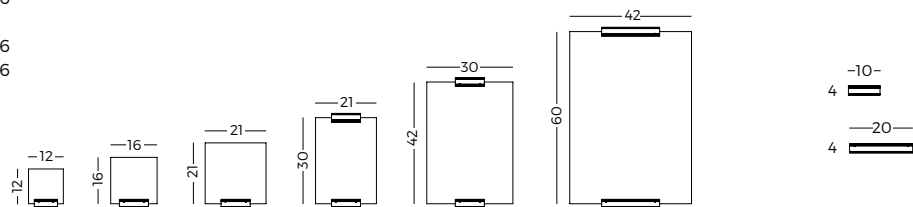

## PICTOGRAMAS Y DIRECTORIOS "GRIP"

**ESP.** Sistema de señalización de interiores fabricado en aluminio y vidrio. La pinza "Grip" de aluminio disponible en diversos formatos sujeta el rótulo situado entre el cristal y la trasería metálica. Disponible en versión mural, sobremesa y con soporte.

## WALL SIGN "GRIP"

**ENG.** Signing system for the inside in anodized aluminium and glass. The grip is available in various sizes. Wall, table or stand version. Delivered with one allen key. Picto and text not included.

## SIGNALÉTIQUE MURALE "GRIP"

**FRA.** Système de signalisation d'intérieur en aluminium anodisé et verre. La pince est disponible en divers formats, version murale, sur table ou avec piétement. Livré avec une clé allen. Picto et texte non inclus.



# GR/M

PICTOGRAMAS Y DIRECTORIOS "GRIP"  
WALL SIGN "GRIP" - SIGNALÉTIQUE MURALE "GRIP"



REF	DESC.	L	H
GR/10	Soporte	4 x 10	1,6
GR/20	Soporte	4 x 20	1,6

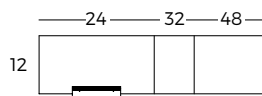
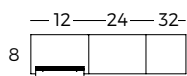
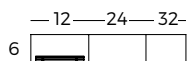

REF	DESC.	L	H
GR/6/12/M	Panel	6 x 12	1,6
GR/6/24/M	Panel	6 x 24	1,6
GR/6/32/M	Panel	6 x 32	1,6
GR/8/12/M	Panel	8 x 12	1,6
GR/8/24/M	Panel	8 x 24	1,6
GR/8/32/M	Panel	8 x 32	1,6
GR/12/24/M	Panel	12 x 24	1,6
GR/12/32/M	Panel	12 x 32	1,6
GR/12/48/M	Panel	12 x 48	1,6



## PICTOGRAMAS Y DIRECTORIOS "GRIP"

**ESP.** Sistema de señalización de interiores fabricado en aluminio y vidrio. La pinza "Grip" de aluminio disponible en diversos formatos sujeta el rótulo situado entre el cristal y la trasera metálica. Disponible en versión mural, sobremesa y con soporte.

## WALL SIGN "GRIP"

**ENG.** Signing system for the inside in anodized aluminium and glass. The grip is available in various sizes. Wall, table or stand version. Delivered with one allen key. Picto and text not included.

## SIGNALÉTIQUE MURALE "GRIP"

**FRA.** Système de signalisation d'intérieur en aluminium anodisé et verre. La pince est disponible en divers formats, version murale, sur table ou avec piétement. Livré avec une clé allen. Picto et texte non inclus.

# GR/SB

RÓTULOS DE SOBREMESA "GRIP"  
SIGN FOR TABLE "GRIP" - SIGNALÉTIQUE SUR TABLE "GRIP"



REF	L	H
GR/6/12/SB	6 x 12	4,5
GR/8/24/SB	8 x 24	4,5
GR/16/SB	16 x 16	4,5
GR/A4/SB	30 x 21	4,5

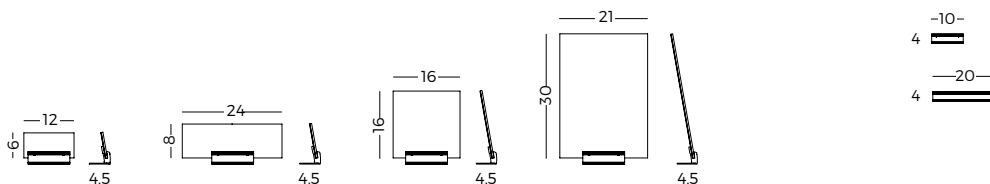

## RÓTULOS DE SOBREMESA "GRIP"

**ESP.** Sistema de señalización de interiores fabricado en aluminio y vidrio. La pinza "Grip" de aluminio disponible en diversos formatos sujeta el rótulo situado entre el cristal y la traseira metálica. Disponible en versión mural, sobremesa y con soporte.

## SIGN FOR TABLE "GRIP"

**ENG.** Signing system for the inside in anodized aluminium and glass. The grip is available in various sizes. Wall, table or stand version. Delivered with one allen key. Picto and text not included

## SIGNALÉTIQUE SUR TABLE "GRIP"

**FRA.** Système de signalisation d'intérieur en aluminium anodisé et verre. La pince est disponible en divers formats, version murale, sur table ou avec piétement. Livré avec une clé allen. Picto et texte non inclus.



# GR/P

RÓTULOS "GRIP" CON SOPORTE

TAGLINE "GRIP" WITH SUPPORT - SIGNALÉTIQUE "GRIP" SUR PIÉTEMENT

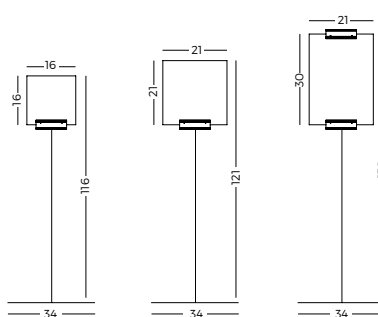

REF	L	H
GR/16/P	16 x 16	116
GR/21/P	21 x 21	121
GR/A4/P	30 x 21	130



## RÓTULOS "GRIP" CON SOPORTE

**ESP.** Sistema de señalización de interiores fabricado en aluminio y vidrio. La pinza "Grip" de aluminio disponible en diversos formatos sujeta el rótulo situado entre el cristal y la trasera metálica. Disponible en versión mural, sobremesa y con soporte.

## TAGLINE "GRIP" WITH SUPPORT

**ENG.** Signing system for the inside in anodized aluminium and glass. The grip is available in various sizes. Wall, table or stand version. Delivered with one allen key. Picto and text not included.

## SIGNALÉTIQUE "GRIP" SUR PIÉTEMENT

**FRA.** Système de signalisation d'intérieur en aluminium anodisé et verre. La pince est disponible en divers formats, version murale, sur table ou avec piétement. Livré avec une clé allen. Picto et texte non inclus.



# ICONOS

PICTOGRAMAS  
ICONS - ICONES



Rotulable  
Inscribable  
Inscriptable



No rotulable  
Not inscribable  
Non-inscriptable



Escritura con tiza  
Chalk writing  
Ecriture à la craie



Trazo digital  
Digital use  
Trait digital



Blocs de papel  
Paper blocs  
Blocs du papier



Personalizable  
Customizable  
Personnalisé



Magnético  
Magnetic  
Magnétique



No magnético  
Not magnetic  
Non-magnétique



Perforable  
Suitable for pins  
Aptes aux punaises



Adhesivo  
Adhesive  
Adhésif



Doble cara  
Double sided  
Double face



Sujección incluida  
Fitting included  
Ferrures inclus



Puerta abatible vert.  
Vert. swing door  
Portes battante vert.



Puerta abatible hor.  
Hor. swing door  
Portes battante hor.



Incluye ruedas  
Castors included  
Avec roulettes



Incluye ruedas  
Castors included  
Avec roulettes



Ajustable en altura  
Adjustable height  
Régable en hauteur



Volteable  
Flip - flop  
Volteable



Puerta corredera  
Sliding doors  
Portes coulissantes



Incluye cerradura  
Lock included  
Serrure incluse



Sistema seguridad  
Security system  
Serrure de sécurité



Resistente  
Weatherproof  
Résistant



Inflamable  
Flammable  
Inflammable



Kit de iluminación  
Light kit  
Kit lumière

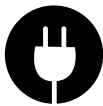

Kit de iluminación  
Light kit  
Kit lumière



Incluye herramientas  
Tools included  
Visserie inclus



Incluye nivelador  
Adjustable base  
Socles ajustables









Acústico  
Acoustic  
Acoustique





# COLORES

COLORES  
COLOUR CHART - COULEURS

Superficie de pizarra Writing surface Superficie d'écriture	 <b>RAL 9003</b> Blanca - /BL White - /BL Blanc - /BL	 <b>RAL 5012</b> Azul claro - /AZ Sky blue - /GR Bleu - /GR	 <b>RAL 7012</b> Gris - /GR Grey - /GR Gris - /GR	 <b>RAL 6028</b> Verde - /VD Green - /VD Vert - /VD	 <b>RAL 5023</b> Azul - /AZ Blue - /AZ Bleu - /AZ	 <b>RAL 7015</b> Negra - /NG Black - /NG Noir - /NG
Superficie de cristal Glass board Panneau de verre	 <b>RAL 9003</b> Blanca - /BL White - /BL Blanc - /BL	 <b>RAL 1016</b> Amarillo - /AM Yellow - /AM Jaune - /AM	 <b>RAL 6019</b> Verde - /VD Green - /VD Vert - /VD	 <b>RAL 3015</b> Rosa - /RS Pink - /RS Rose - /RS	 <b>RAL 7035</b> Azul - /AZ Blue - /AZ Bleu - /AZ	 <b>RAL 2012</b> Naranja - /NJ Orange - /NJ Orange - /NJ
 <b>RAL 9006</b> Gris - /GR Grey - /GR Gris - /GR	 <b>RAL 1011</b> Marrón - /MR Brown - /MR Marron - /MR	Color de lacado Lacquer colour Couleur laquée	 <b>RAL 9003</b> Blanca - /BL White - /BL Blanc - /BL	 <b>RAL 9006</b> Gris - /GR Grey - /GR Gris - /GR	 <b>RAL 9011</b> Negra - /NG Black - /NG Noir - /NG	 <b>RAL 1013</b> Amarillo - /AM Yellow - /AM Jaune - /AM
 <b>RAL 3024</b> Rojo - /RJ Red - /RJ Rouge - /RJ	 <b>RAL 5012</b> Azul - /AZ Blue - /AZ Bleu - /AZ	 <b>RAL 6016</b> Verde - /VD Green - /VD Vert - /VD	Color de rotulación Sign systems colour Couleur signalétique	 <b>RAL 9010</b> Blanco - 01 White - 01 Blanc - 01	 <b>RAL 1023</b> Amarillo - 29 Yellow - 29 Jaune - 29	 <b>RAL 2002</b> Naranja - 34 Orange - 34 Orange - 34
 <b>RAL 3024</b> Rojo - 19 Red - 19 Rouge - 19	 <b>RAL 3004</b> Burdeos - 55 Bordeaux - 55 Bordeaux - 55	 <b>RAL 6018</b> Verde - 78 Green - 78 Vert - 78	 <b>RAL 6017</b> Verde oscuro - 20 Dark green - 20 Vert foncé - 20	 <b>RAL 5021</b> Turquesa - 76 Turquoise - 76 Turquoise - 76	 <b>RAL 5024</b> Azul - 76 Blue - 76 Bleu - 76	 <b>RAL 5017</b> Azul oscuro - /AZ Dark blue - /AZ Bleu foncé - /AZ
 <b>RAL 4001</b> Violeta - 63 Violet - 63 Violet - 63	 <b>RAL 7036</b> Gris - 70 Grey - 70 Gris - 70	 <b>RAL 9004</b> Negro - 57 Black - 57 Noir - 57				



# GRACIAS

POR TU CONFIANZA

THANK YOU OR YOUR CONFIDENCE - MERCI POUR VOTRE CONFIANCE

**ESP.** A vosotros, clientes. Gracias por vuestra confianza y apoyo. Por muchos años más.

**ENG.** To you, our partners. Thank you for your confidence and support. To many more years.

**FRA.** A vous, chez clients. Merci pour votre confiance et support. Pour beaucoup plus d'années.





Planning Sisplamo

Planning Sisplamo SL  
Polígon Industrial Pla d'en Coll  
C/ Camí de la Font Freda 17, nave 4  
08110 Montcada i Reixac  
Barcelona

[www.madedesign.es](http://www.madedesign.es)  
[www.planningsisplamo.com](http://www.planningsisplamo.com)